

MajDec 12-1588 |Delguercio-SJP-  
Delguercio-SJP-+

# PAISWT - 2001

## 16 - 17 February 2001

Wt: 112

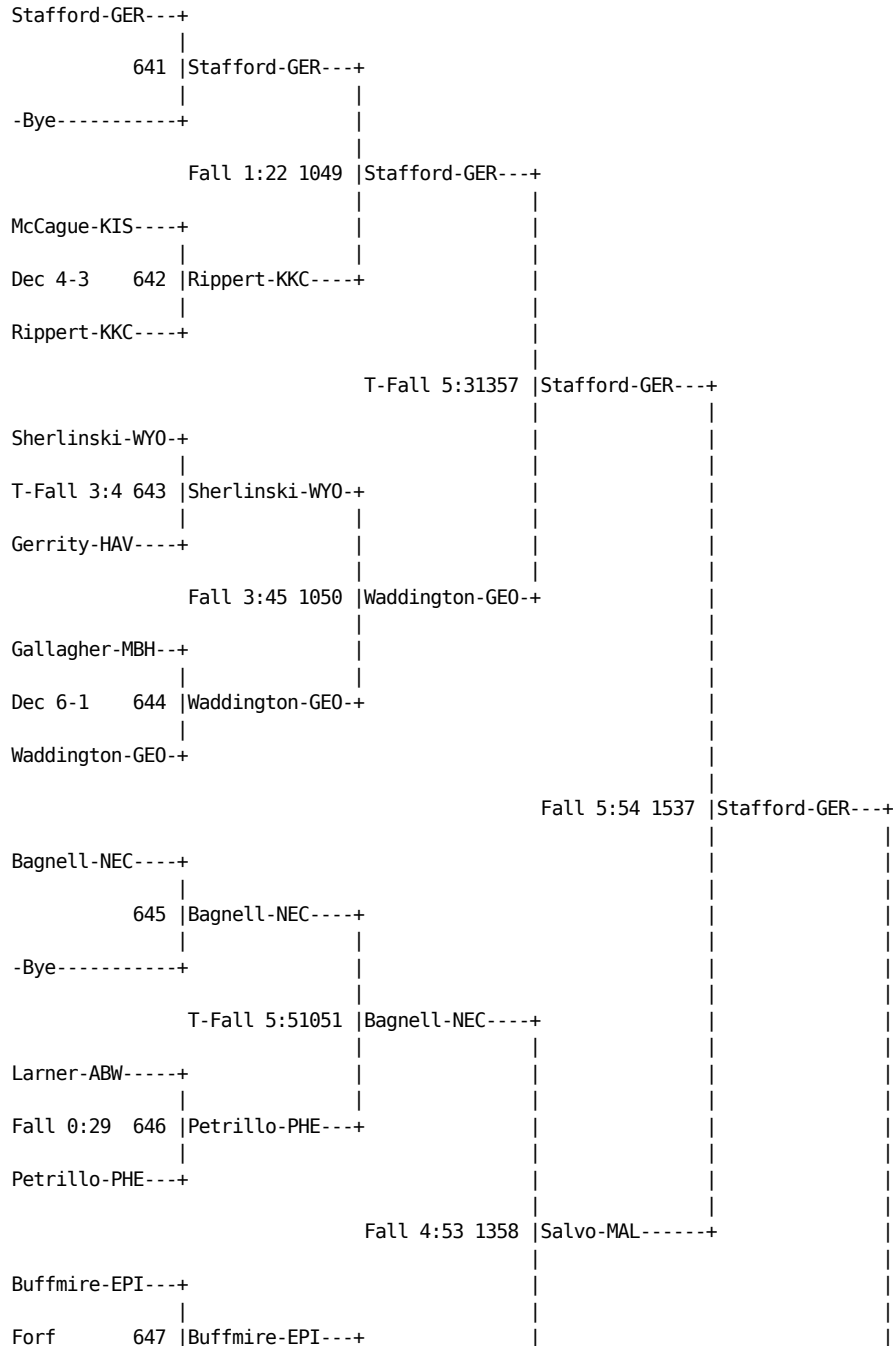

```

Kurtz-CEC-----+
      |
      |MajDec 13-1052|Salvo-MAL-----+
      |
-Bye-----+
      |
      |648|Salvo-MAL-----+
      |
Salvo-MAL-----+
      |
      |Dec 9-3 1594|Stafford-GER---
      |
Groverman-WIP--+
      |
      |649|Groverman-WIP--+
      |
-Bye-----+
      |
      |Fall 1:15 1053|Groverman-WIP--+
      |
Cobb-SJP-----+
      |
Forf 650|Matt Fink-GFR--+
      |
Matt Fink-GFR--+
      |
      |Fall 4:16 1359|Groverman-WIP--+
      |
L'Hommedie-DCH++
      |
      |Fall 5:35 651|L'Hommedie-DCH++
      |
Buzzzone-CHF-----+
      |
      |Fall 4:50 1054|L'Hommedie-DCH++
      |
-Bye-----+
      |
      |652|Frazier-TAC-----+
      |
Frazier-TAC-----+
      |
      |Dec 6-2 1538|Groverman-WIP--+
      |
Damm-ANC-----+
      |
      |653|Damm-ANC-----+
      |
-Bye-----+
      |
      |Fall 0:59 1055|Damm-ANC-----+
      |
Granger-WES-----+
      |
      |Fall 3:52 654|Granger-WES-----+
      |
McKnight-AFR--+
      |
      |Dec 9-2 1360|Batdorf-HIL-----+
      |
Seweryn-LSC-----+
      |
      |Fall 5:11 655|Chris Lu-VFM---+
      |
Chris Lu-VFM---+
  
```



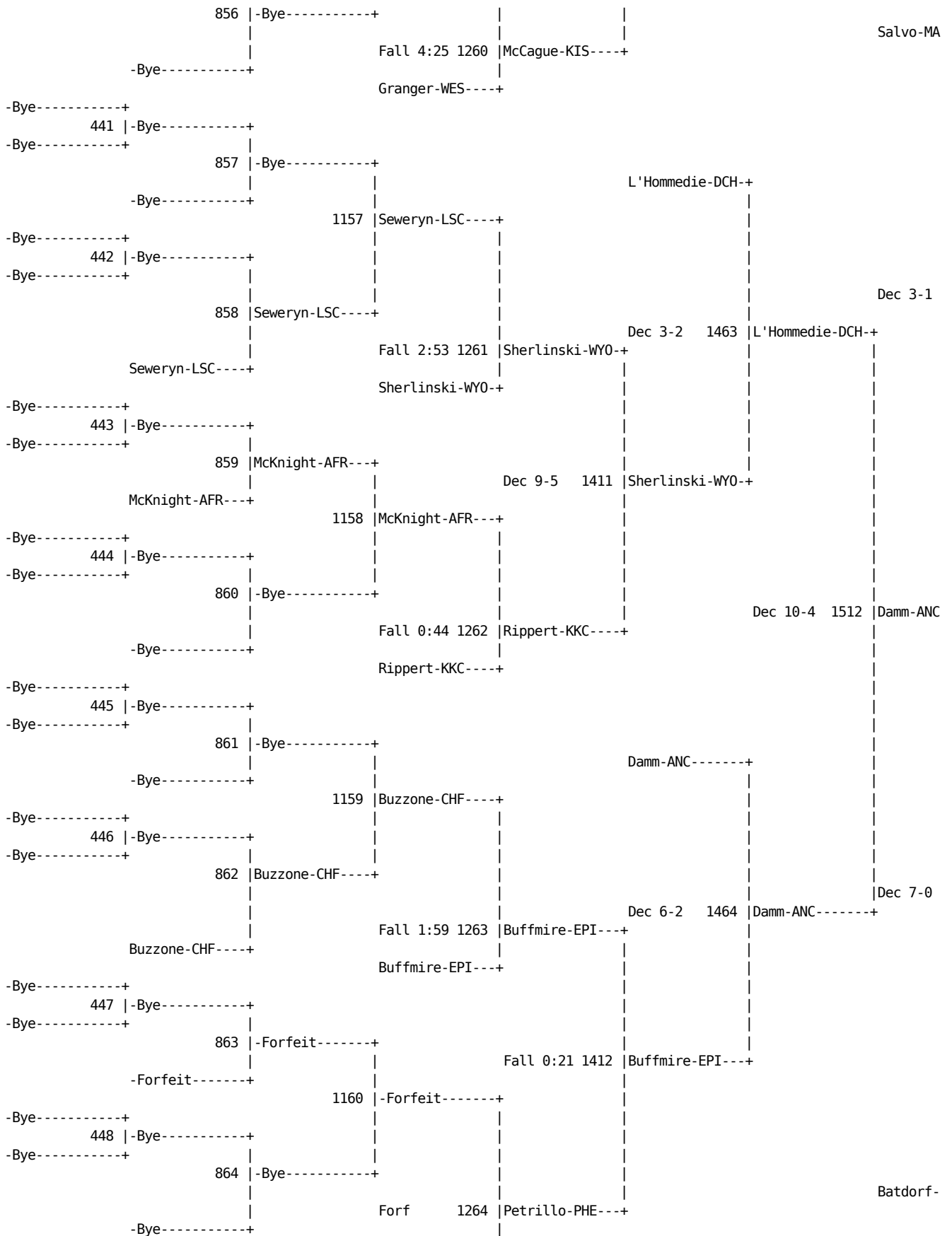



Petrillo-PHE---+  
 Bagnell-NEC----+  
 Dec 5-4 1592 |Damm-ANC-----  
 Damm-ANC-----+

# PAISWT - 2001

16 - 17 February 2001

Wt: 119

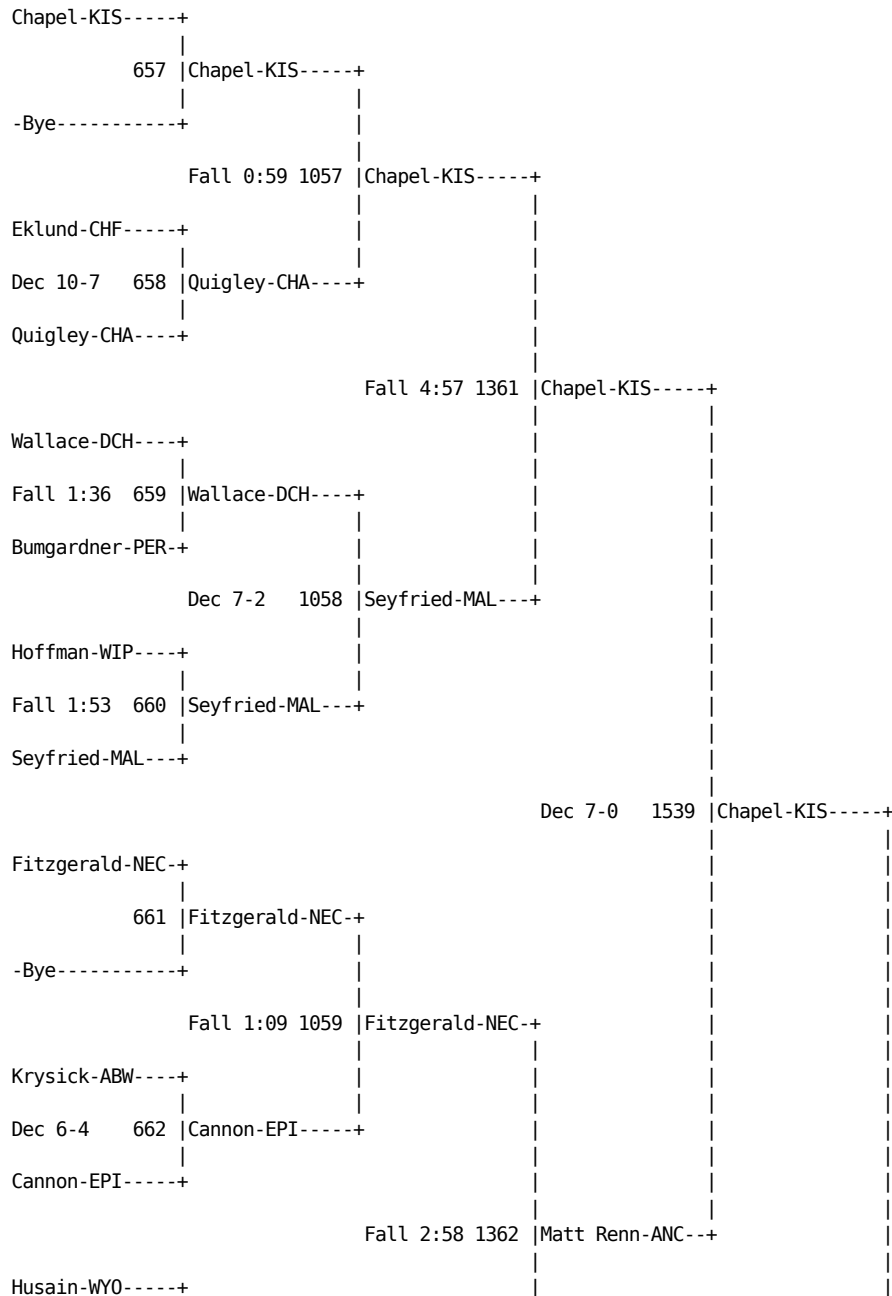

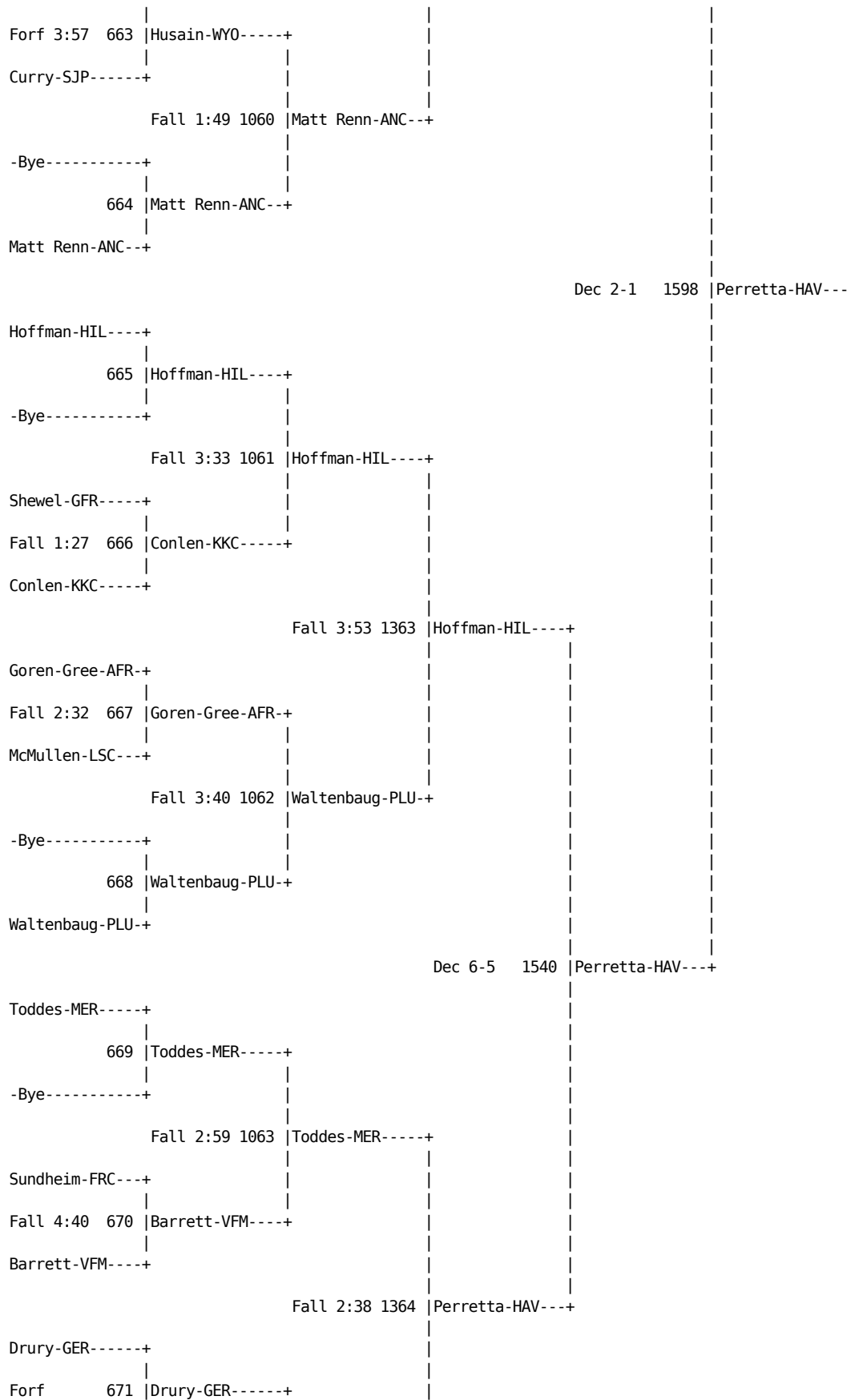









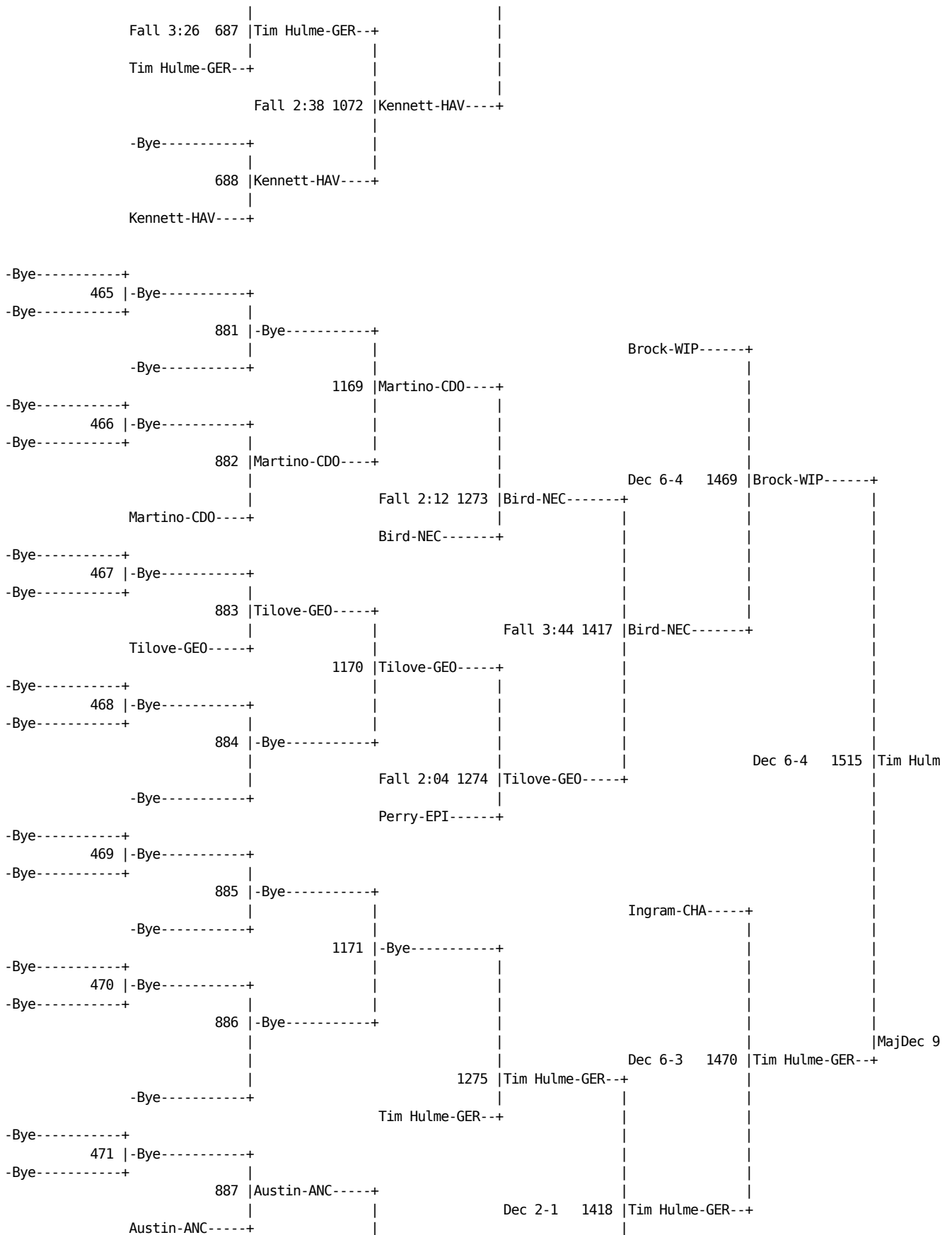

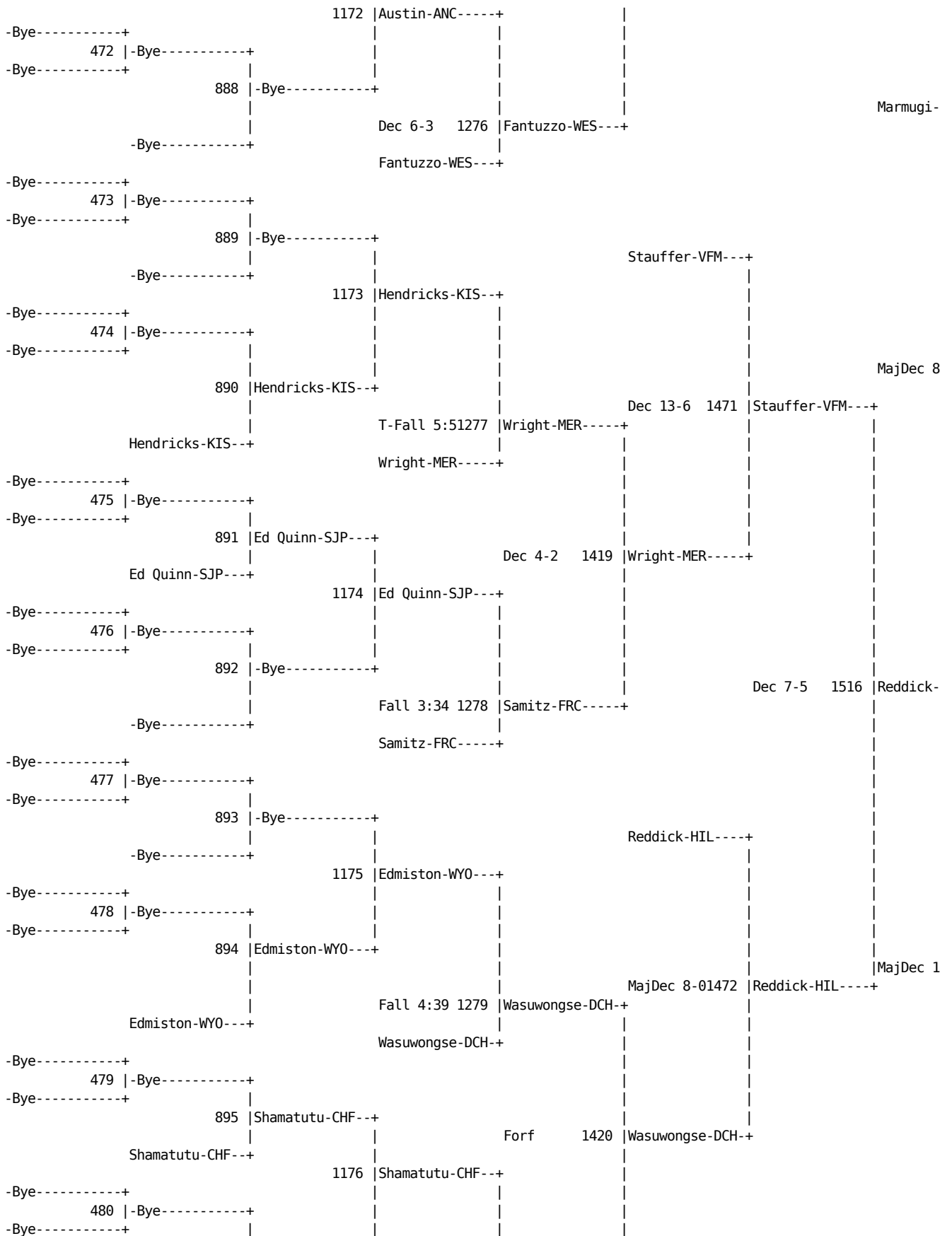





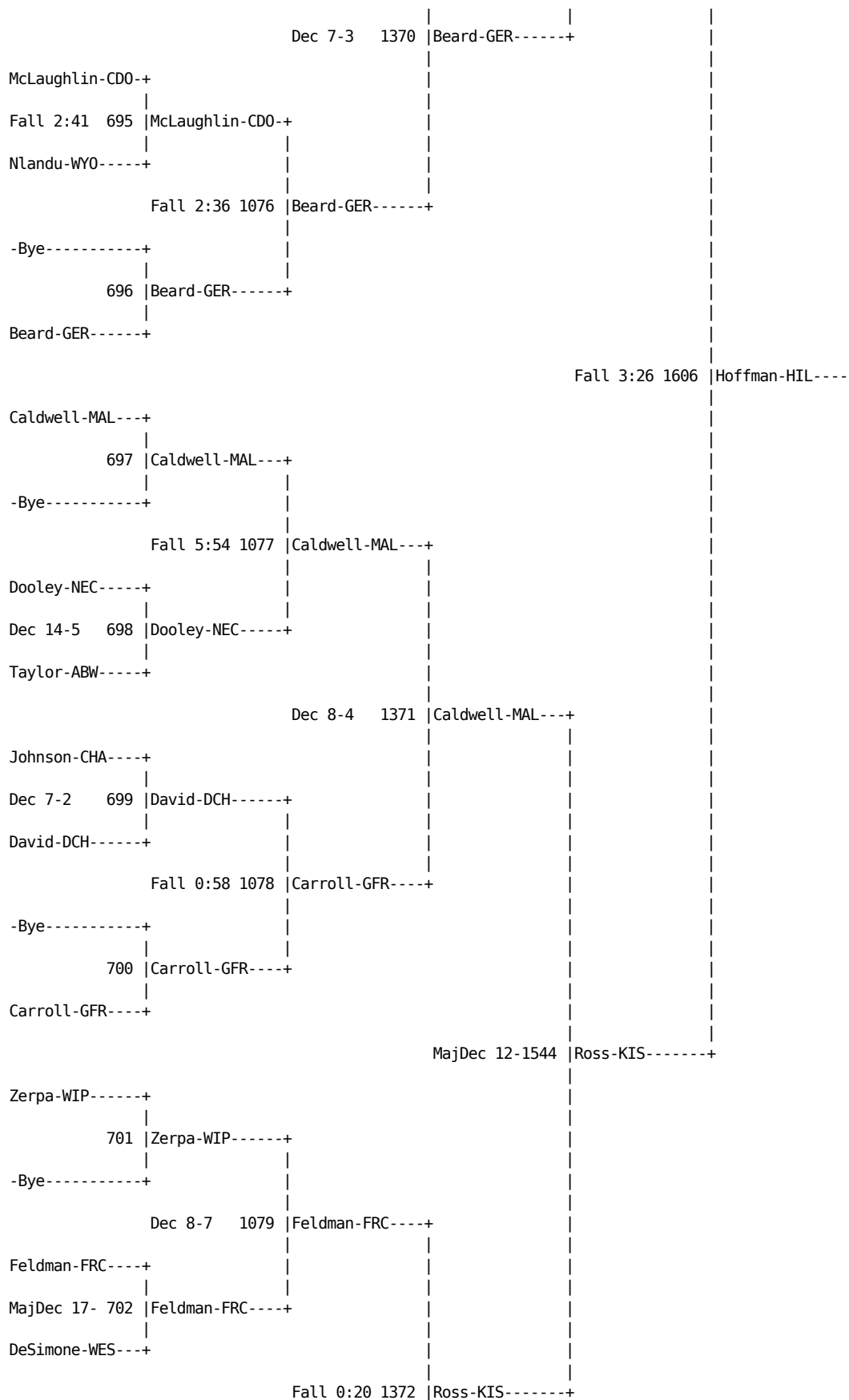

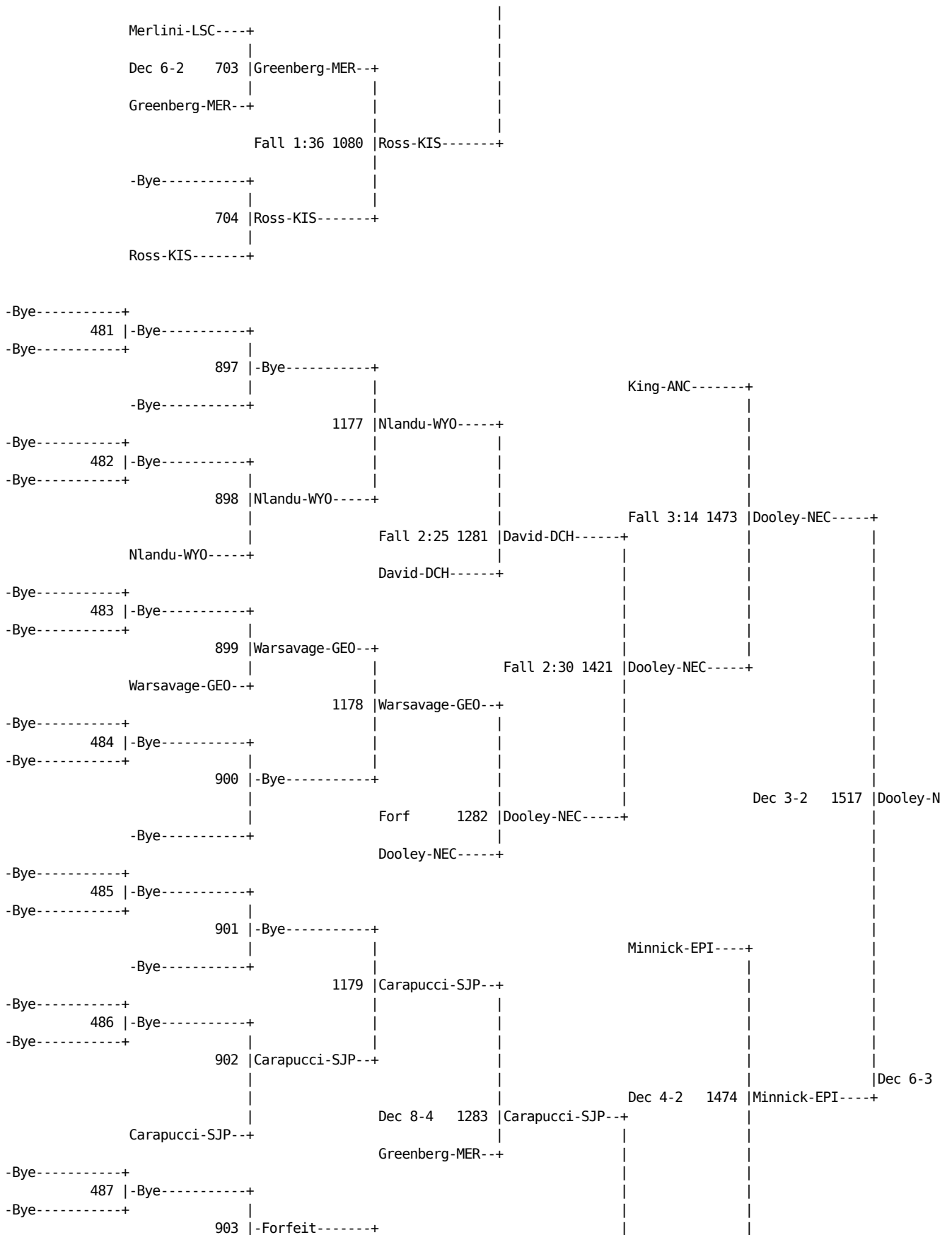

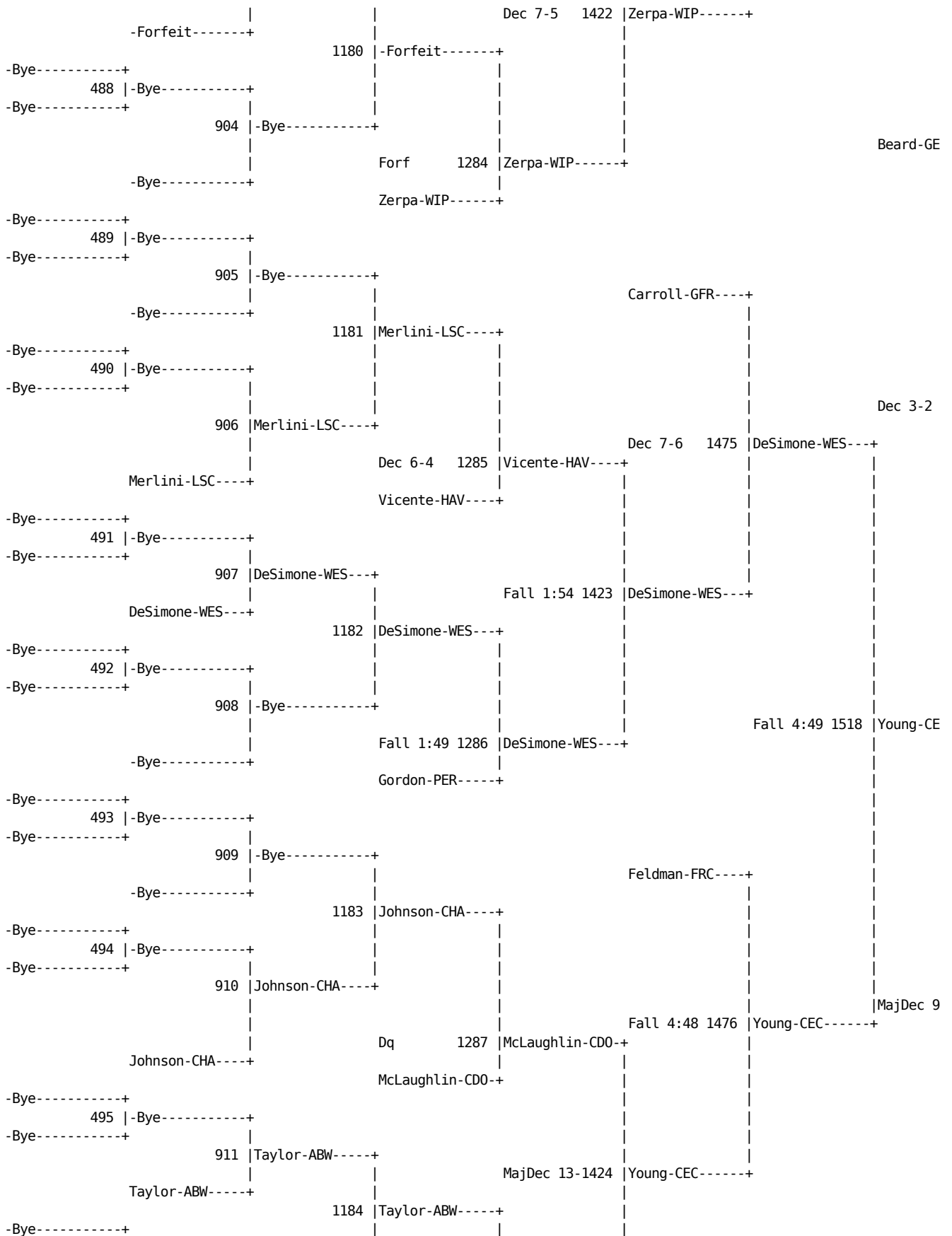

```

496 |-Bye-----+
-Bye-----+
          912 |-Bye-----+
          |
          | Fall 3:20 1288 |Young-CEC-----+
          |
          | Young-CEC-----+
          |
          | Dooley-NEC-----+
          | Fall 3:27 1604 |Dooley-NEC-----+
          | Young-CEC-----+
    
```

Caldwell

---

# PAISWT - 2001

## 16 - 17 February 2001

Wt: 135

---

```

Hopkins-GER----+
          |
          | 705 |Hopkins-GER----+
          |
          | -Bye-----+
          |
          | MajDec 11-1081 |Hopkins-GER----+
          |
          | Cheung-WY0-----+
          |
          | Fall 3:16 706 |O'Neill-MAL-----+
          |
          | O'Neill-MAL-----+
          |
          | MajDec 11-1373 |Hopkins-GER----+
          |
          | Gottschlin-PER--+
          |
          | Fall 1:37 707 |Gottschlin-PER--+
          |
          | Grassey-CHF-----+
          |
          | Dec 7-2 1082 |Gottschlin-PER--+
          |
          | Crumlish-CHA---+
          |
          | Dec 6-2 708 |Vakil-EPI-----+
          |
          | Vakil-EPI-----+
          |
          | Dec 1545 |Hopkins-GER----+
          |
          | Abdullah-KIS---+
          |
          | 709 |Abdullah-KIS---+
          |
          | -Bye-----+
          |
          | Fall 3:40 1083 |Abdullah-KIS---+
          |
          | Schnarr-ANC-----+
          |
          | Fall 4:53 710 |Vjunichenk-GE0--+
    
```

```

Vjunichenk-GEO--+
                                     |
                                     |
                                     |
                                     |
Dec 7-50T 1374 |Dempsey-NEC-----+
                                     |
Silverman-HIL--+
MajDec 16- 711 |Silverman-HIL--+
Curtis-SJP-----+
                                     |
Dec 6-3   1084 |Dempsey-NEC-----+
                                     |
-Bye-----+
                                     |
712 |Dempsey-NEC-----+
                                     |
Dempsey-NEC-----+
                                     |
                                     |
Dec 8-2   1610 |Hopkins-GER----
                                     |
Wentworth-MBH--+
713 |Wentworth-MBH--+
-Bye-----+
                                     |
Fall 1:01 1085 |Wentworth-MBH--+
                                     |
Howard-GFR-----+
Fall 2:58 714 |Howard-GFR-----+
Sommers-DCH-----+
                                     |
T-Fall 4:51375 |Resnick-HAV-----+
                                     |
Miller-WES-----+
MajDec 17- 715 |Miller-WES-----+
Schmidt-ABW-----+
                                     |
Fall 5:20 1086 |Resnick-HAV-----+
                                     |
-Bye-----+
716 |Resnick-HAV-----+
Resnick-HAV-----+
                                     |
Dec 8-2   1546 |Hitschler-WIP--+
                                     |
Pozzuolo-FRC---+
Fall 1:37 717 |Pozzuolo-FRC---+
Kelly-PHE-----+
Dec 2-0   1087 |Miller-VFM-----+
Lowenthal-MER--+
Fall 2:37 718 |Miller-VFM-----+
Miller-VFM-----+
    
```

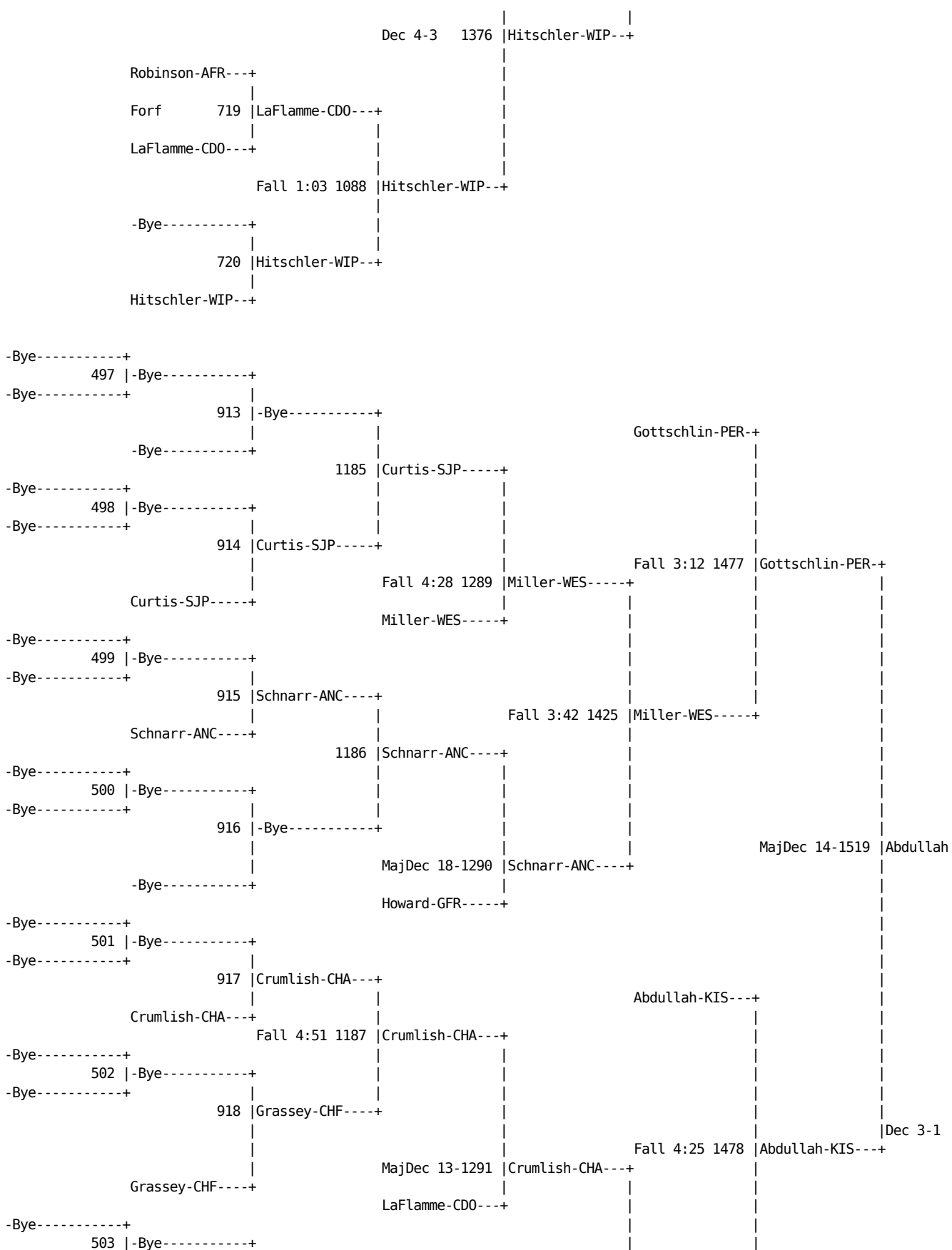

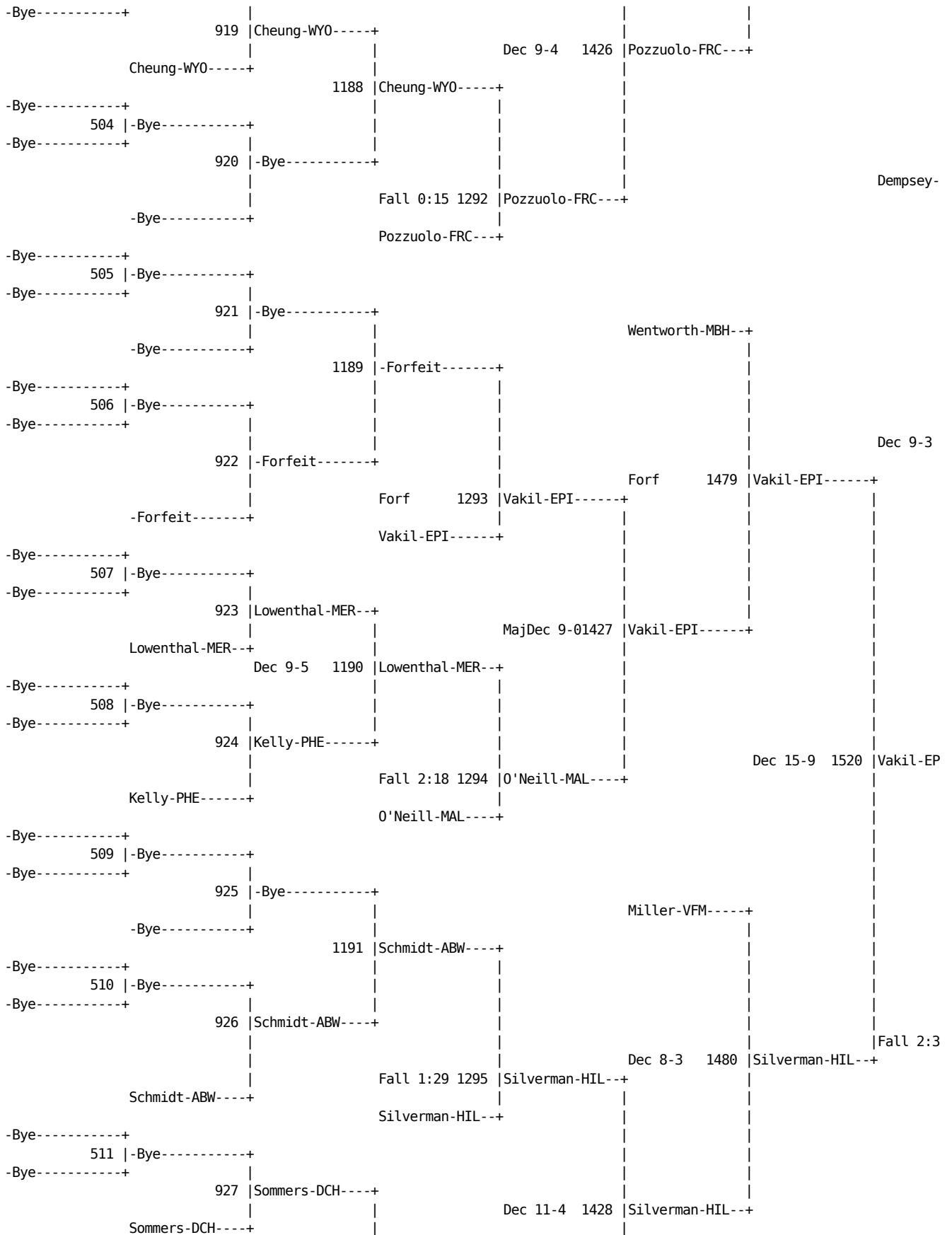



```

1192 |Sommers-DCH----+
-Bye-----+
512 |-Bye-----+
-Bye-----+
928 |-Bye-----+
-Bye-----+
Fall 0:51 1296 |Vjunichenk-GEO--+
Vjunichenk-GEO--+
Abdullah-KIS---+
Fall 1:53 1608 |Abdullah-KIS---
Vakil-EPI-----+
Resnick-
    
```

---

# PAISWT - 2001

16 - 17 February 2001

Wt: 140

```

Storniolo-HAV--+
721 |Storniolo-HAV--+
-Bye-----+
Fall 0:23 1089 |Storniolo-HAV--+
Jon Meter-FRS--+
Fall 2:23 722 |Jon Meter-FRS--+
Shannon-TAC----+
Fall 0:27 1377 |Storniolo-HAV--+
Quinn-CHF-----+
Fall 3:03 723 |Quinn-CHF-----+
Haines-DCH-----+
Fall 4:33 1090 |Quinn-CHF-----+
Sheerin-ABW----+
Fall 3:16 724 |Sheerin-ABW----+
Whelan-LSC-----+
Fall 1:21 1547 |Storniolo-HAV--+
Hull-KKC-----+
Fall 0:29 725 |Hull-KKC-----+
Rivera-CD0-----+
MajDec 17-1091 |Hull-KKC-----+
Hamilton-MBH----+
    
```

```

Forf      726 |McKinstry-WES---+
            |
McKinstry-WES---+
            |
            |Dec 6-2  1378 |Mascino-NEC----+
            |
Smith-PER-----+
            |
Fall 1:45 727 |Mehalick-EPI---+
            |
Mehalick-EPI---+
            |
            |Fall 0:44 1092 |Mascino-NEC----+
            |
Diduch-CEC-----+
            |
Fall 4:38 728 |Mascino-NEC----+
            |
Mascino-NEC----+
            |
            |Dflt      1614 |Storniolo-HAV--
            |
Lukof-GER-----+
            |
            |729 |Lukof-GER-----+
            |
-Bye-----+
            |
            |Dec 8-2  1093 |Lukof-GER-----+
            |
Bernstein-FRC---+
            |
Dec 9-1   730 |Fuchs-HIL-----+
            |
Fuchs-HIL-----+
            |
            |Dec 3-2  1379 |Lukof-GER-----+
            |
Kelly-MAL-----+
            |
Fall 1:56 731 |Kramer-PLU-----+
            |
Kramer-PLU-----+
            |
            |Dflt      1094 |Andrew Ha-VFM--++
            |
Rogerson-AFR---+
            |
Forf      732 |Andrew Ha-VFM--++
            |
Andrew Ha-VFM--++
            |
            |Dec 7-5  1548 |Lukof-GER-----+
            |
Berkman-GFR----+
            |
MajDec 13- 733 |Berkman-GFR----+
            |
Seibel-KIS-----+
            |
            |Fall 3:43 1095 |Berkman-GFR----+
            |
Titus-GE0-----+
            |
Dec 11-7  734 |Walter-ANC-----+
            |
    
```

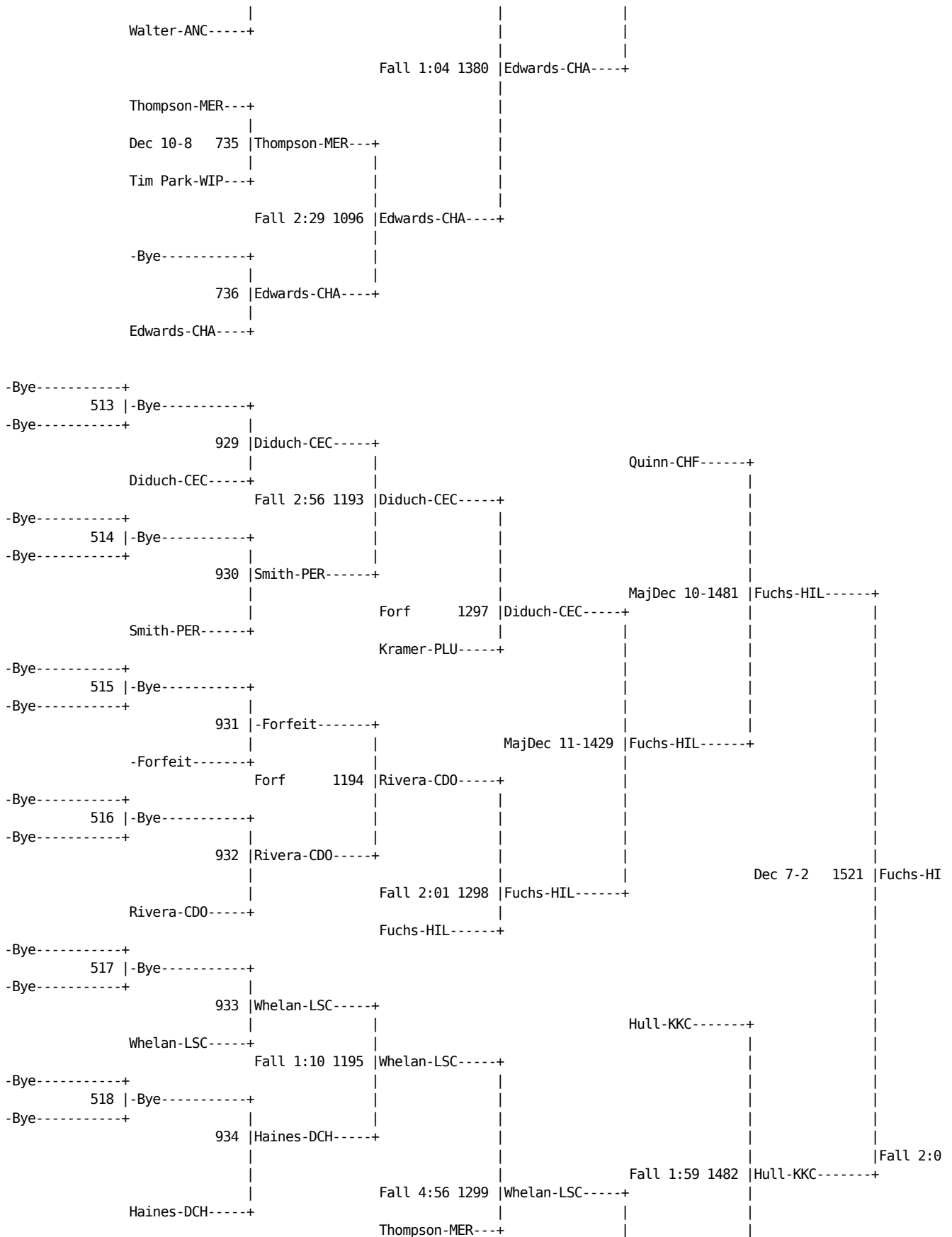

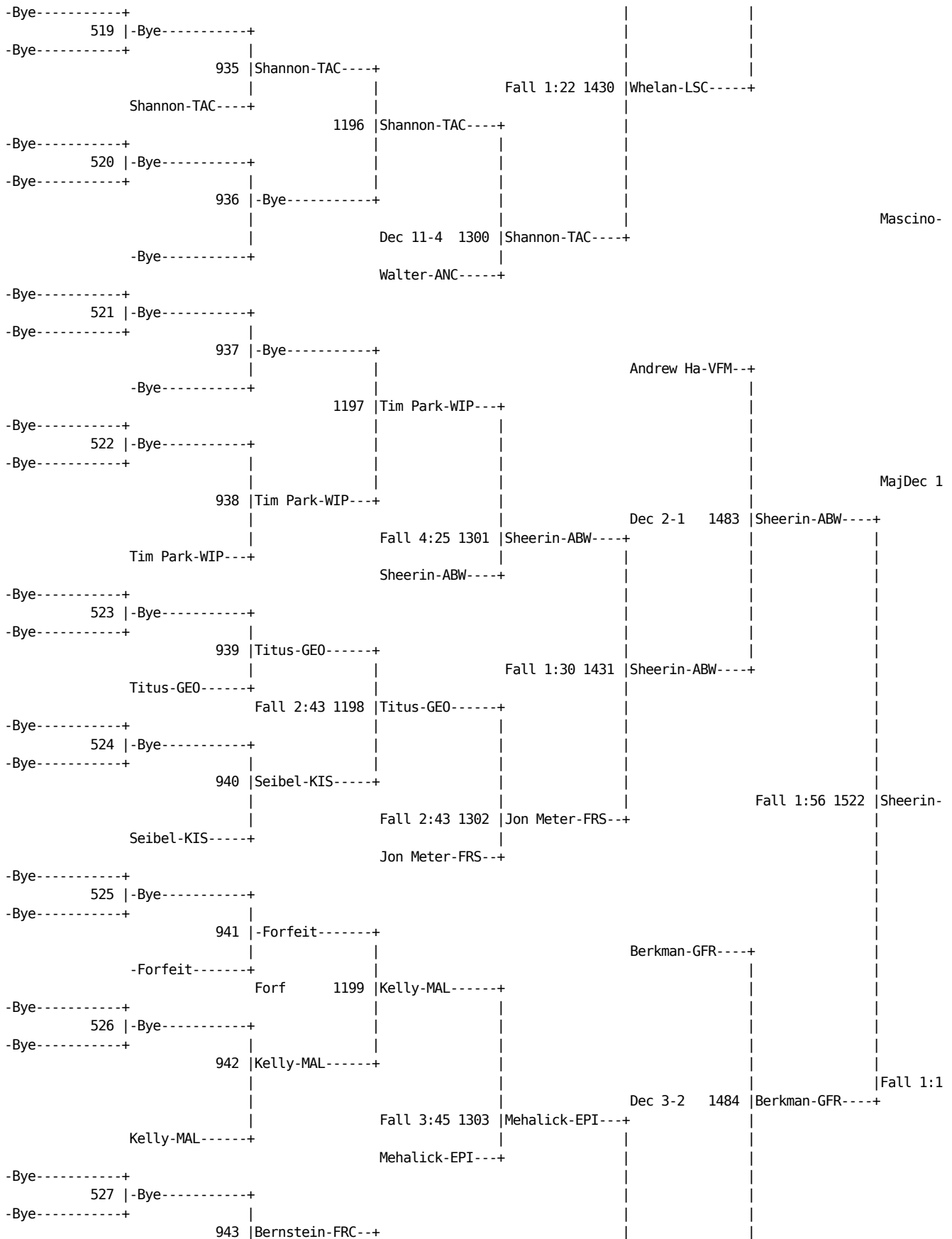

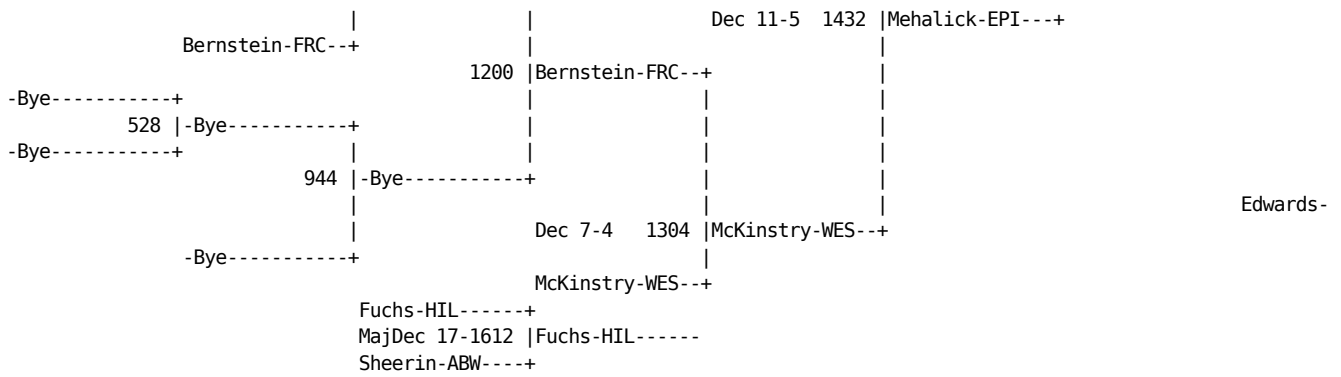

# PAISWT - 2001

16 - 17 February 2001

Wt: 145

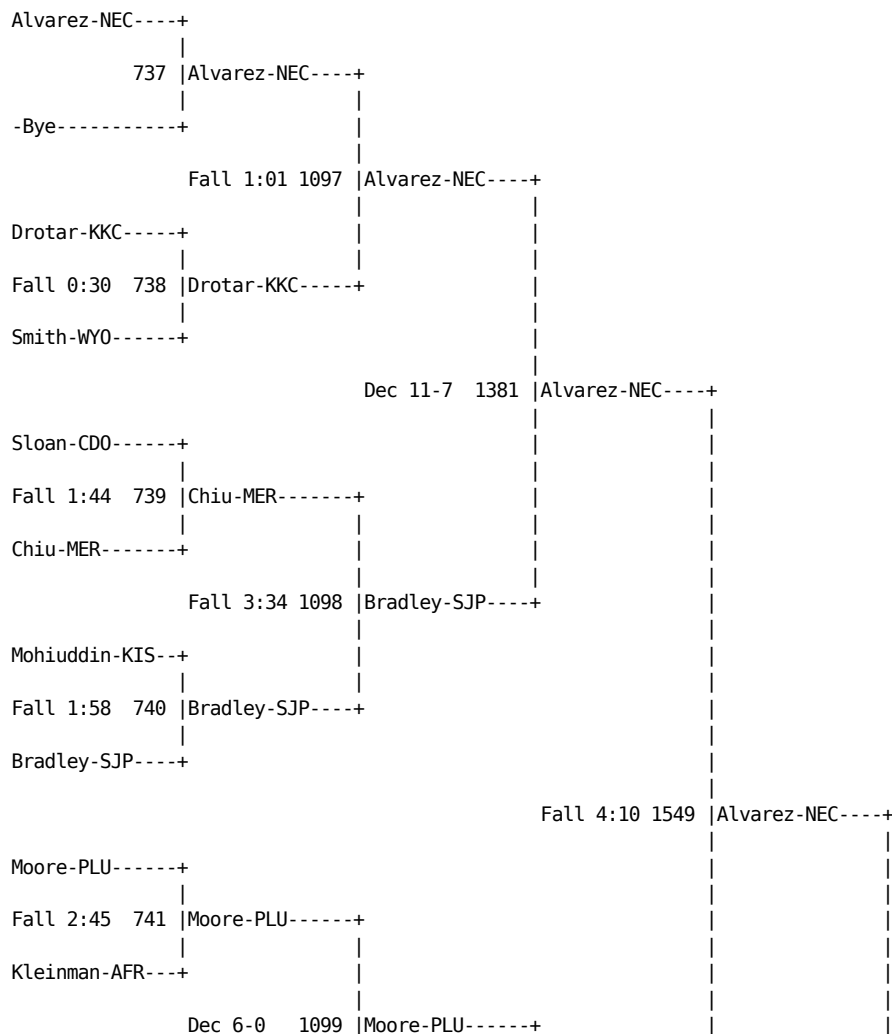

```

Nauer-HIL-----+
|
MajDec 8-0 742 |Rebar-TAC-----+
|
Rebar-TAC-----+
|
| Dec 5-2 1382 |Salvo-MAL-----+
|
Hornstein-FRC--+
|
Dec 6-2 743 |Hornstein-FRC--+
|
Greiner-LSC----+
|
| Fall 2:42 1100 |Salvo-MAL-----+
|
Reardon-EPI----+
|
Fall 5:01 744 |Salvo-MAL-----+
|
Salvo-MAL-----+
|
| Dec 6-4 1618 |Hopkins-GER----
|
Jin Kim-WIP----+
|
Fall 4:31 745 |Jin Kim-WIP----+
|
Holby-WES-----+
|
| Fall 1:09 1101 |Jin Kim-WIP----+
|
Heier-ANC-----+
|
Forf 746 |Heier-ANC-----+
|
Balsinger-PER--+
|
| Fall 2:13 1383 |Jin Kim-WIP----+
|
Seymour-CHA----+
|
Fall 0:51 747 |Fisher-HAV-----+
|
Fisher-HAV-----+
|
| Fall 9-5 1102 |Fisher-HAV-----+
|
Worth-VFM-----+
|
Forf 748 |Worth-VFM-----+
|
Dorean-DCH-----+
|
| Dec 4-0 1550 |Hopkins-GER----+
|
Burghardt-CEC--+
|
Fall 1:33 749 |Burghardt-CEC--+
|
Barry-PHE-----+
|
| Dec 12-9 1103 |Burghardt-CEC--+
|
Abdul-Kari-GEO--+
|
|
|

```

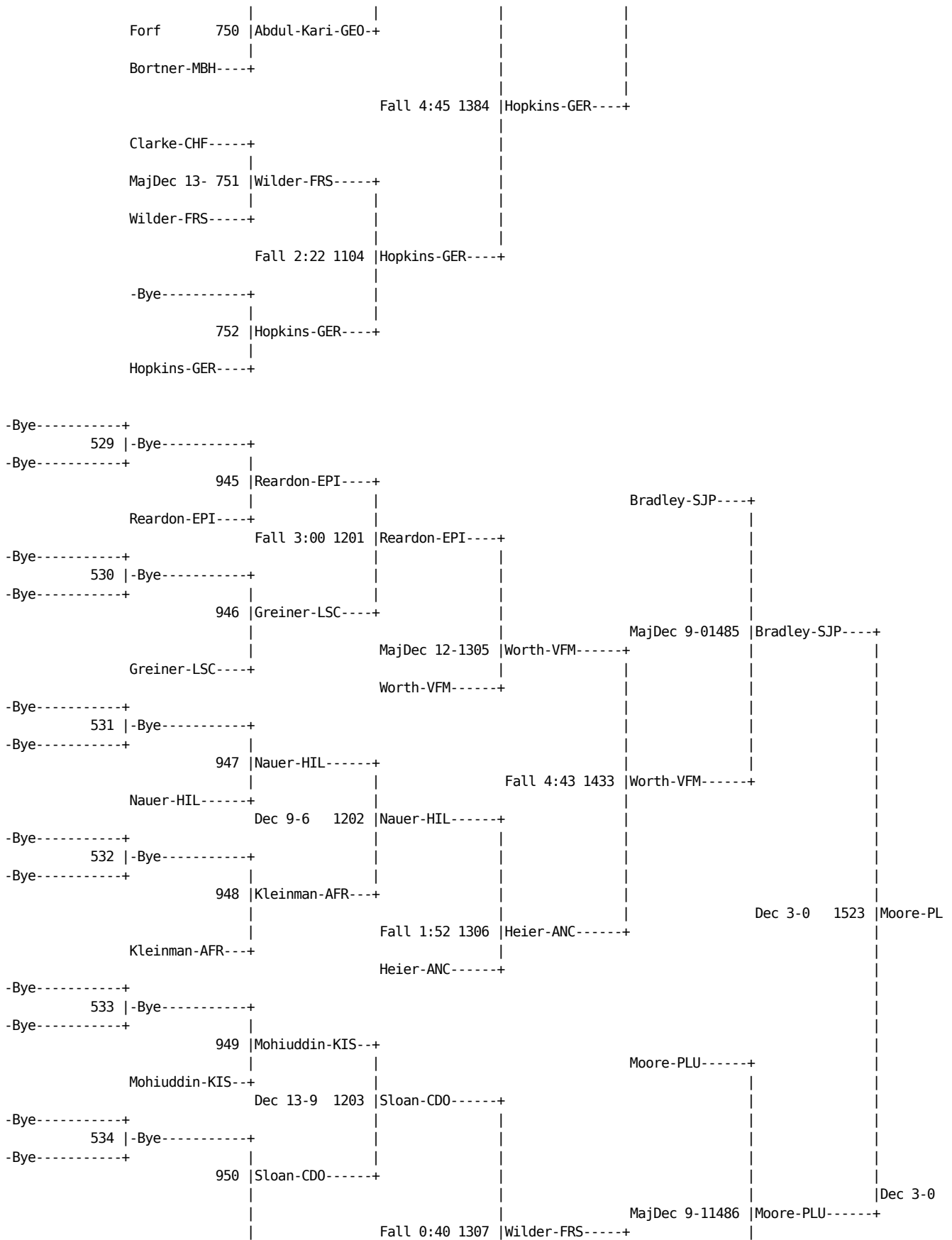





```

-Bye-----+
          |
          959 | -Forfeit-----+
          |
          | -Forfeit-----+
          | Forf      1208 | Holby-WES-----+
          |
          | -Bye-----+
          | 544 | -Bye-----+
          | -Bye-----+
          | 960 | Holby-WES-----+
          |
          |
          | Fall 4:54 1312 | Holby-WES-----+
          | Holby-WES-----+
          |
          | Rebar-TAC-----+
          | Moore-PLU-----+
          | Dec 8-1 1616 | Burghardt-CEC--
          | Burghardt-CEC--+
  
```

Jin Kim-

---

# PAISWT - 2001

## 16 - 17 February 2001

### Wt: 152

---

```

Myers-GER-----+
          |
          753 | Myers-GER-----+
          |
          | -Bye-----+
          |
          | Fall 0:47 1105 | Myers-GER-----+
          |
          | Casey-SJP-----+
          | Fall 3:53 754 | Casey-SJP-----+
          |
          | Josh Paul-CHA--+
          |
          | T-Fall 5:11385 | Myers-GER-----+
          |
          | Taylor-MER-----+
          | Fall 5:51 755 | Taylor-MER-----+
          |
          | Meunier-WES-----+
          |
          | Dec 7-6 1106 | Taylor-MER-----+
          |
          | Painter-DCH-----+
          |
          | T-Fall 5:2 756 | O'Donnell-NEC--+
          |
          | O'Donnell-NEC--+
          |
          |
          | Fall 1:32 1551 | Myers-GER-----+
          |
          | Johnson-PLU-----+
          |
          | 757 | Johnson-PLU-----+
          |
          | -Bye-----+
  
```

```

      Fall 0:35 1107 |Johnson-PLU-----+
Reiley-MBH-----+
Forf      758 |Sheltzer-FRC----+
Sheltzer-FRC----+
      Dec 4-2   1386 |Bullen-PER-----+
Burgess-EPI-----+
Dec 10-4   759 |Sladek-VFM-----+
Sladek-VFM-----+
      Fall ) :57 1108 |Bullen-PER-----+
-Bye-----+
      760 |Bullen-PER-----+
Bullen-PER-----+
      Dec 8-5   1622 |Myers-GER-----+
Mandracchi-HIL-+
      761 |Mandracchi-HIL-+
-Bye-----+
      Fall 3:45 1109 |Mandracchi-HIL-+
Strain-GFR-----+
Fall 0:45 762 |Strain-GFR-----+
Foldes-WY0-----+
      Dec 7-5   1387 |Mandracchi-HIL-+
Haworth-GEO-----+
Fall 2:23 763 |Marini-KIS-----+
Marini-KIS-----+
      Dec 11-1  1110 |Black-LSC-----+
-Bye-----+
      764 |Black-LSC-----+
Black-LSC-----+
      MajDec 10-1552 |Alden-ANC-----+
Osborne-MAL-----+
      765 |Osborne-MAL-----+
-Bye-----+
      Fall 5:38 1111 |Osborne-MAL-----+
    
```

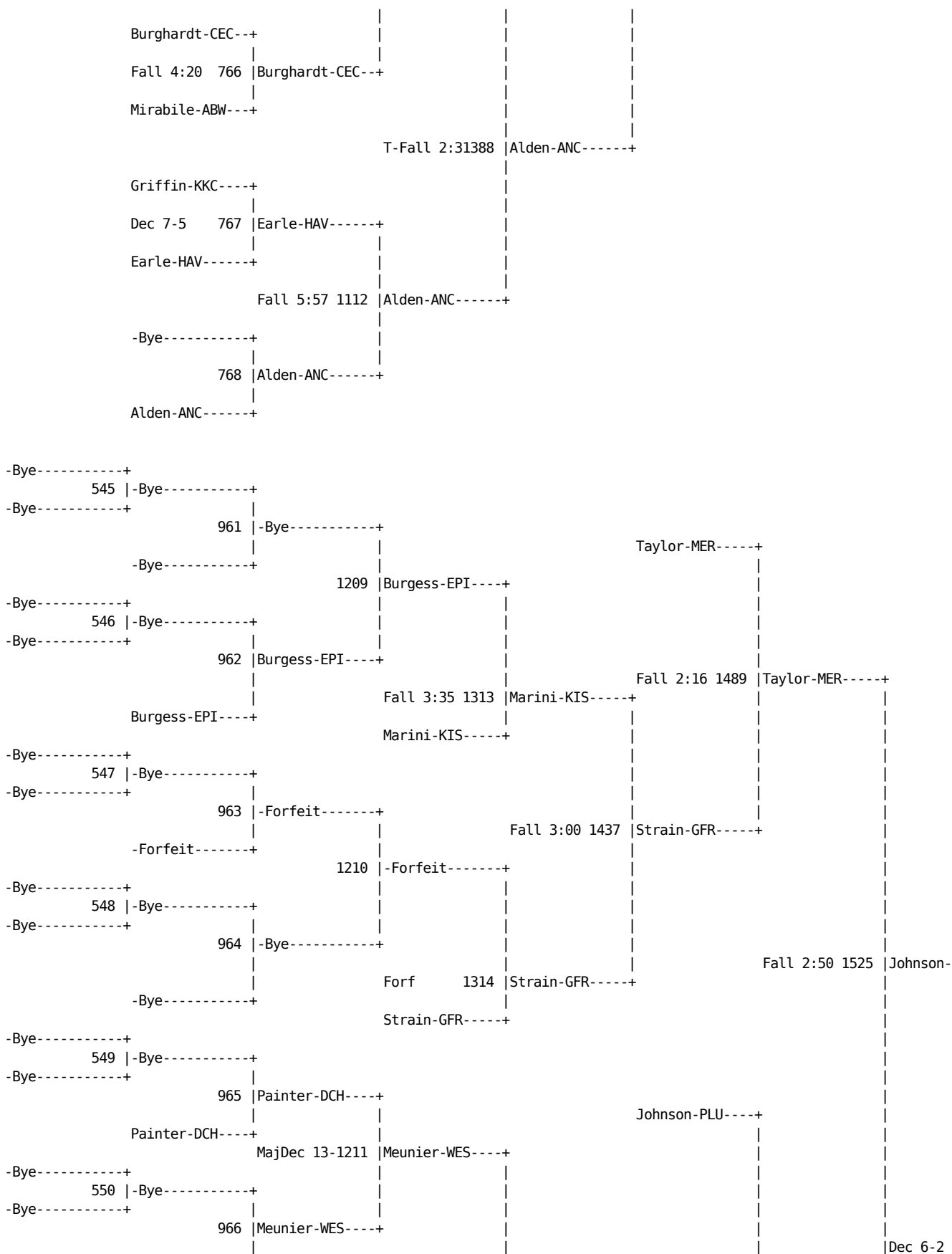



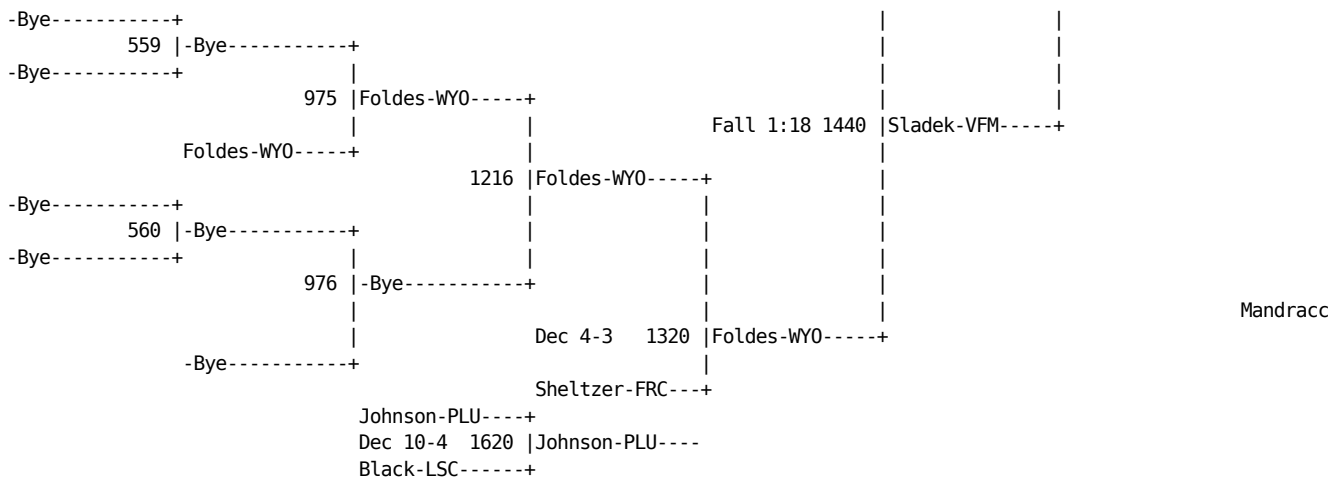

# PAISWT - 2001

16 - 17 February 2001

Wt: 160

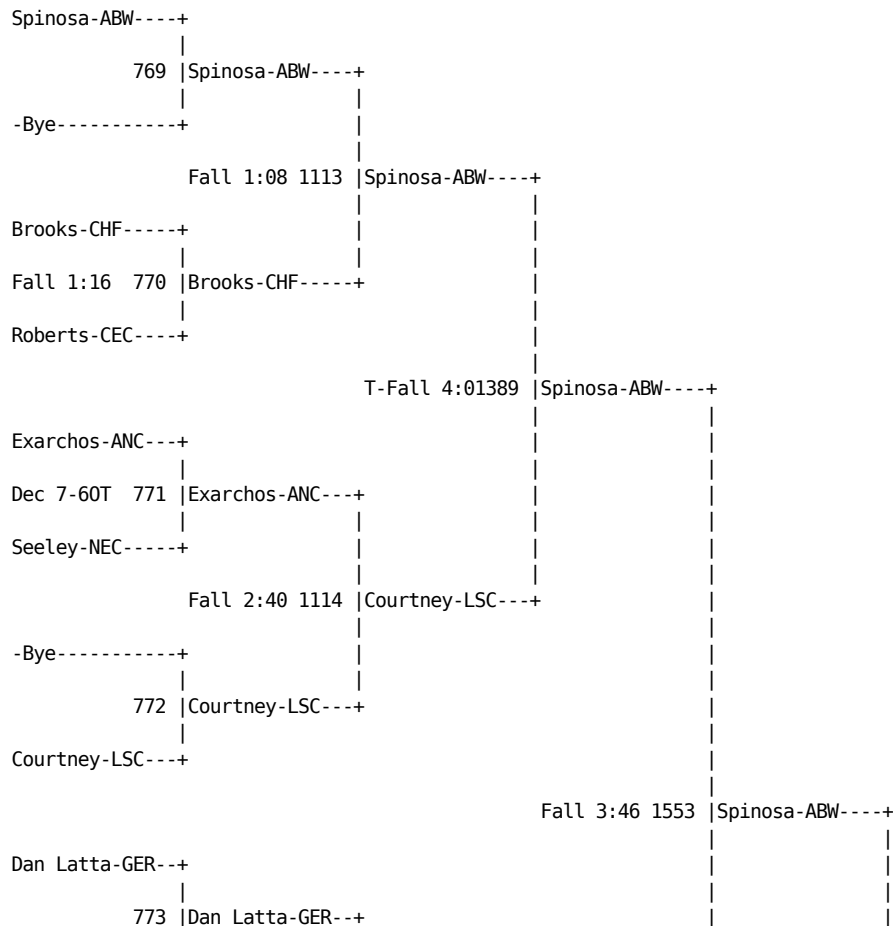

```

-Bye-----+
      |
      | Fall 2:22 1115 | Dan Latta-GER--++
Blanchet-MER---+
      |
      | Fall 0:45 774 | Blanchet-MER---+
McKnight-CD0---+
      |
      | Dec 9-6 1390 | Dan Latta-GER--++
Meyer-FRC-----+
      |
      | Fall 1:25 775 | Coyle-SJP-----+
Coyle-SJP-----+
      |
      | Fall 1:56 1116 | Miller-EPI-----+
-Bye-----+
      |
      | 776 | Miller-EPI-----+
Miller-EPI-----+
      |
      | Dec 8-5 1626 | Spinosa-ABW----
Elbaum-WIP-----+
      |
      | 777 | Elbaum-WIP-----+
-Bye-----+
      |
      | MajDec 15-1117 | Elbaum-WIP-----+
Wes Ykema-DCH--++
      |
      | Fall 1:11 778 | Morgan-HIL-----+
Morgan-HIL-----+
      |
      | Dec 10-5 1391 | Elbaum-WIP-----+
Esplen-TAC-----+
      |
      | Fall 0:56 779 | Esplen-TAC-----+
Kelley-MAL-----+
      |
      | Fall 3:18 1118 | Sagin-GFR-----+
-Bye-----+
      |
      | 780 | Sagin-GFR-----+
Sagin-GFR-----+
      |
      | Fall 3:12 1554 | Jeff Hart-MBH--++
Comerota-AFR---+
      |
      | 781 | Comerota-AFR---+
-Bye-----+
      |
  
```

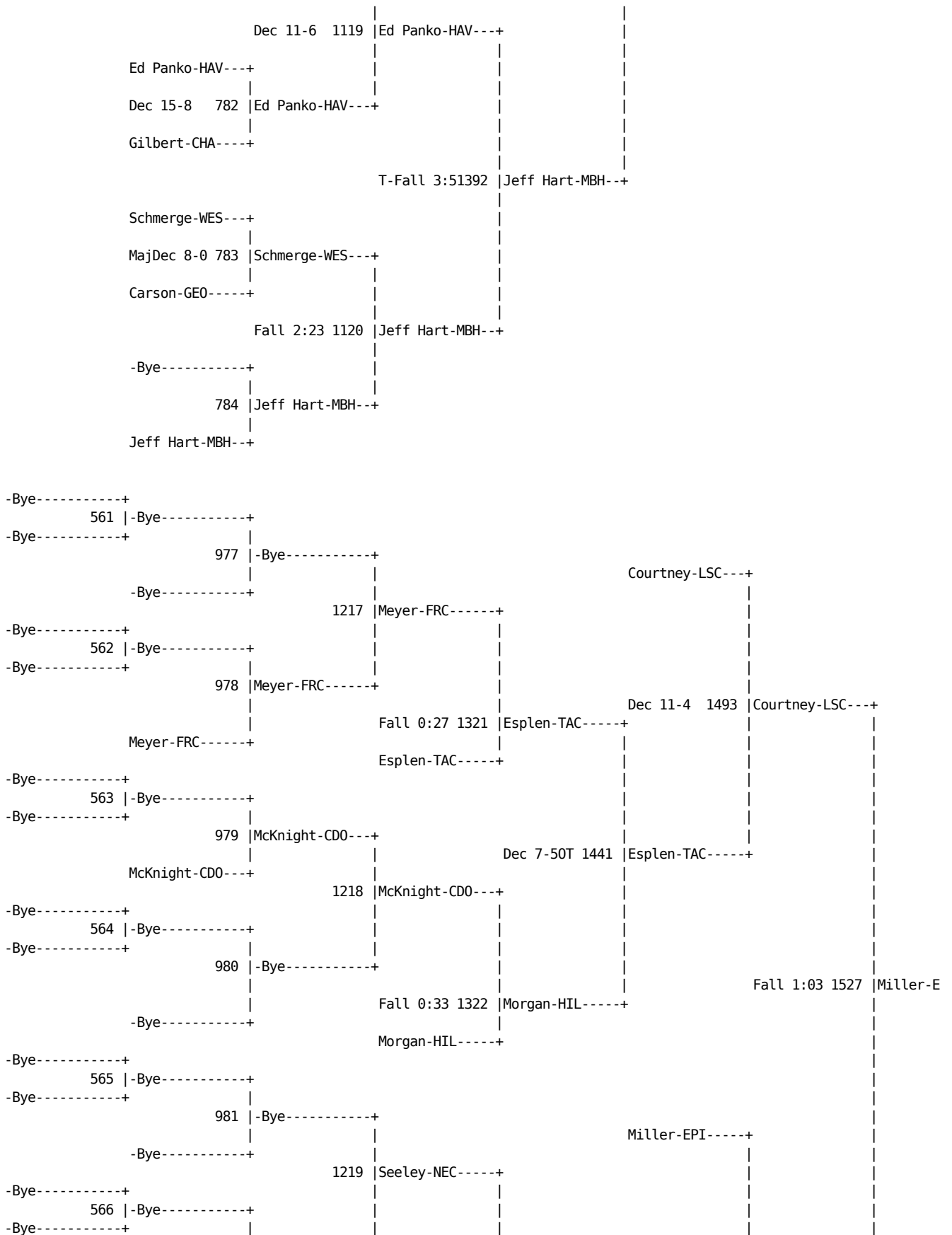

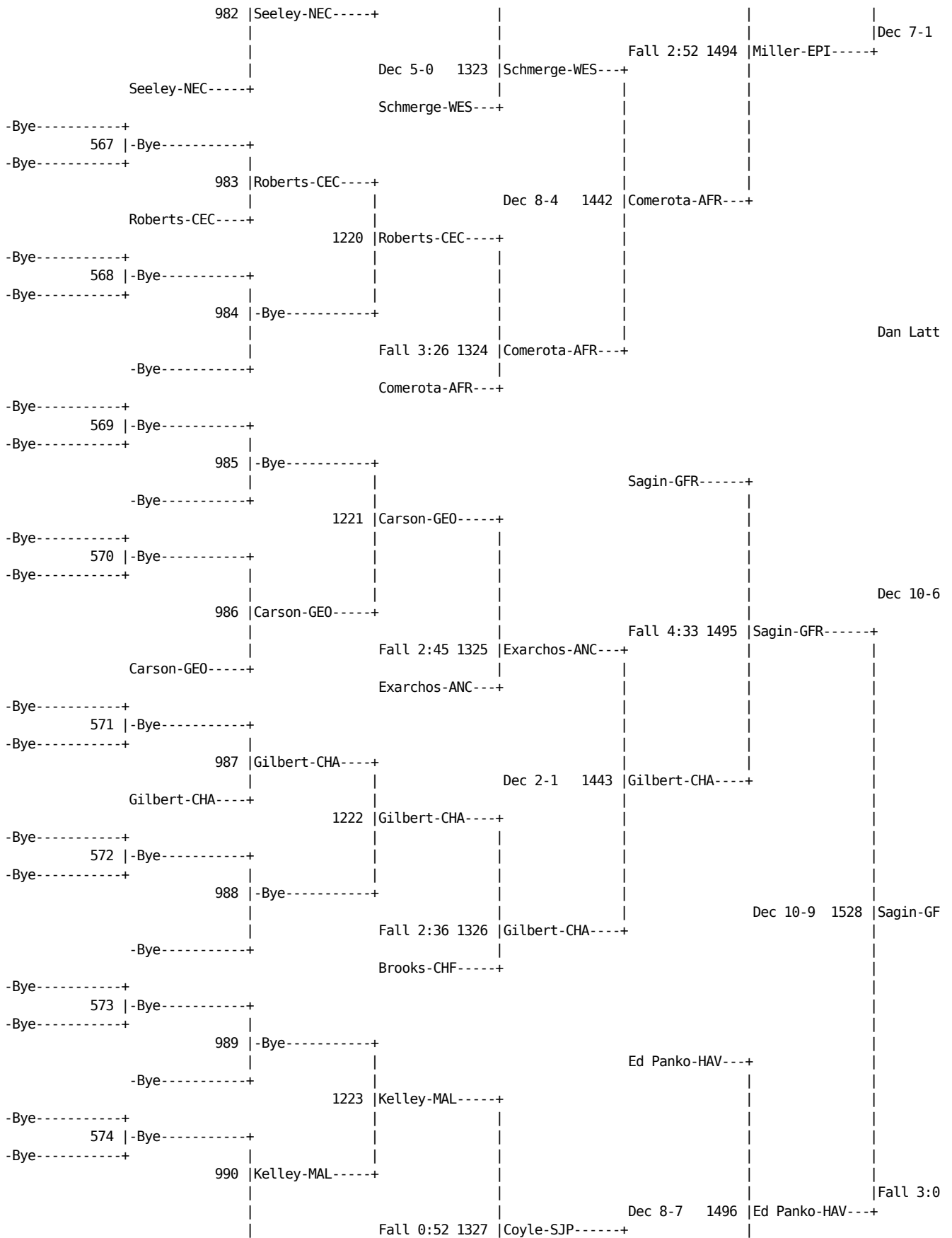



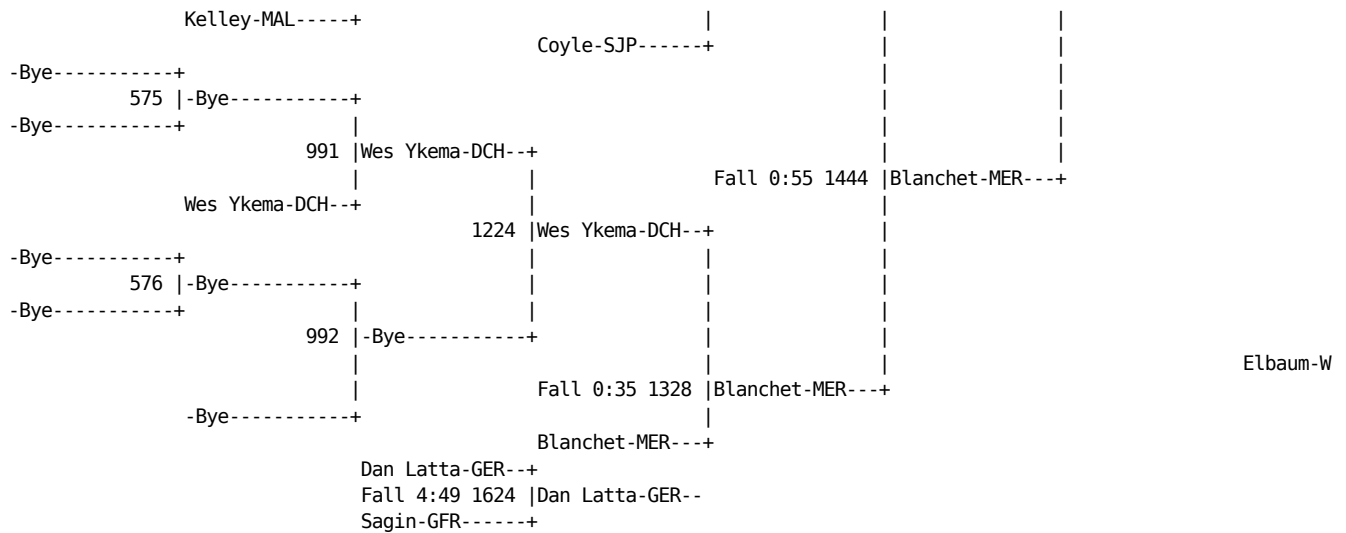

# PAISWT - 2001

16 - 17 February 2001

Wt: 171

---

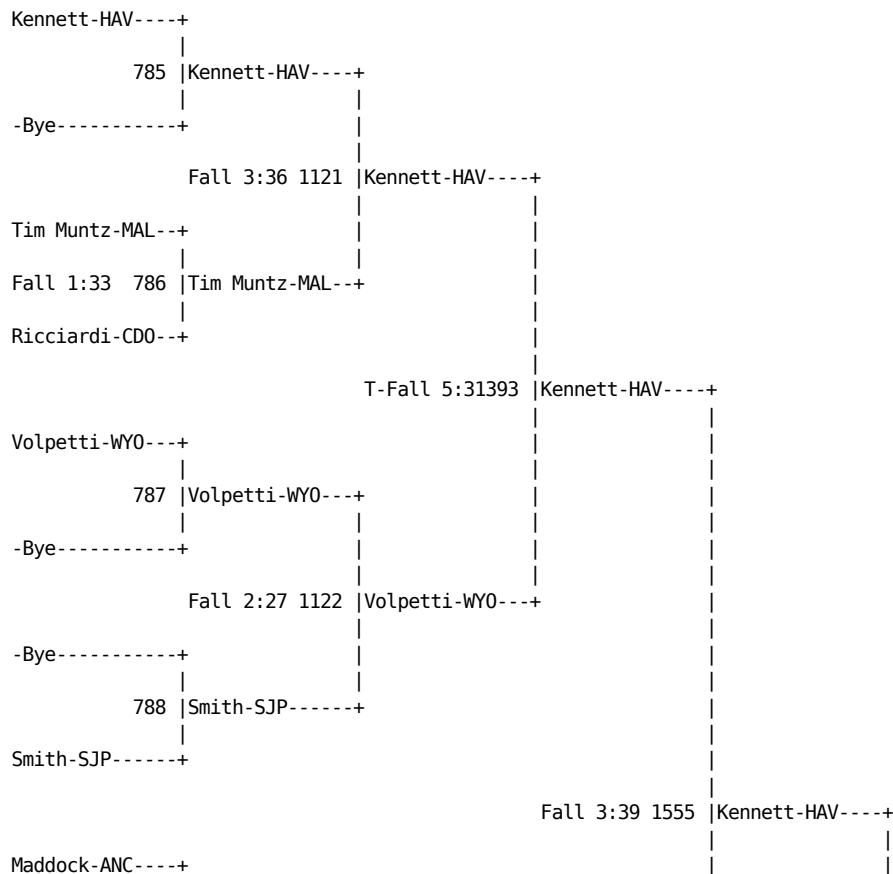

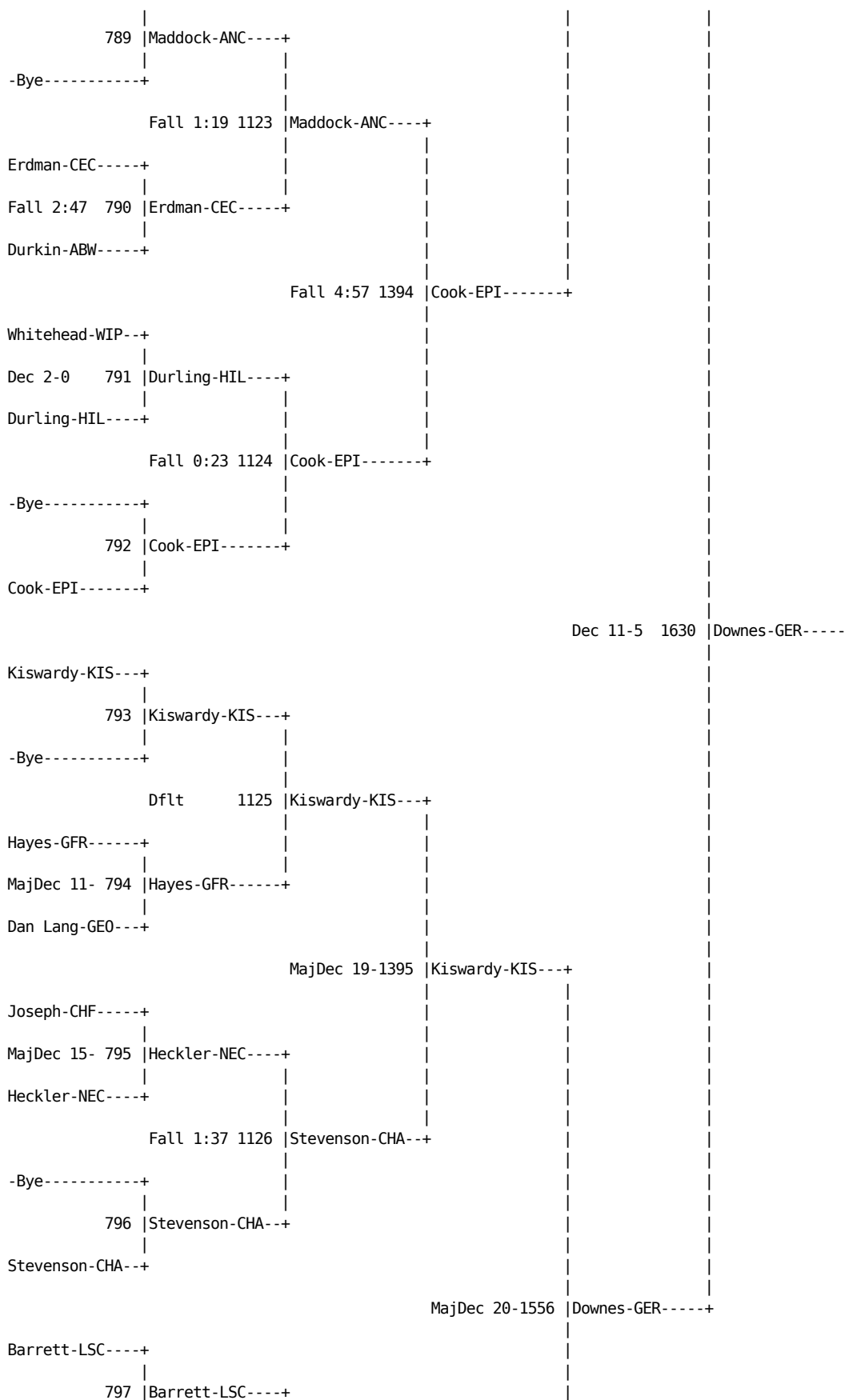

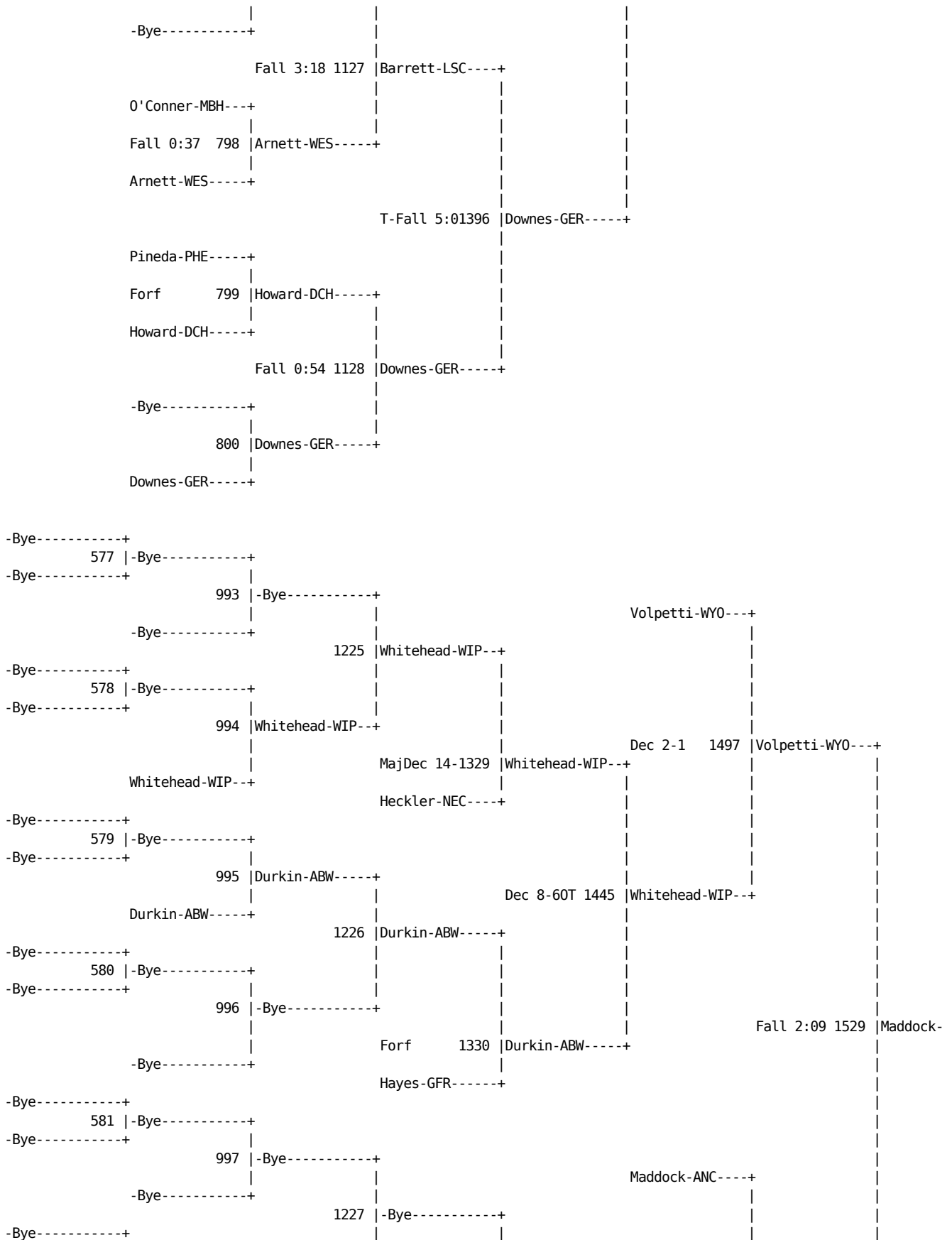

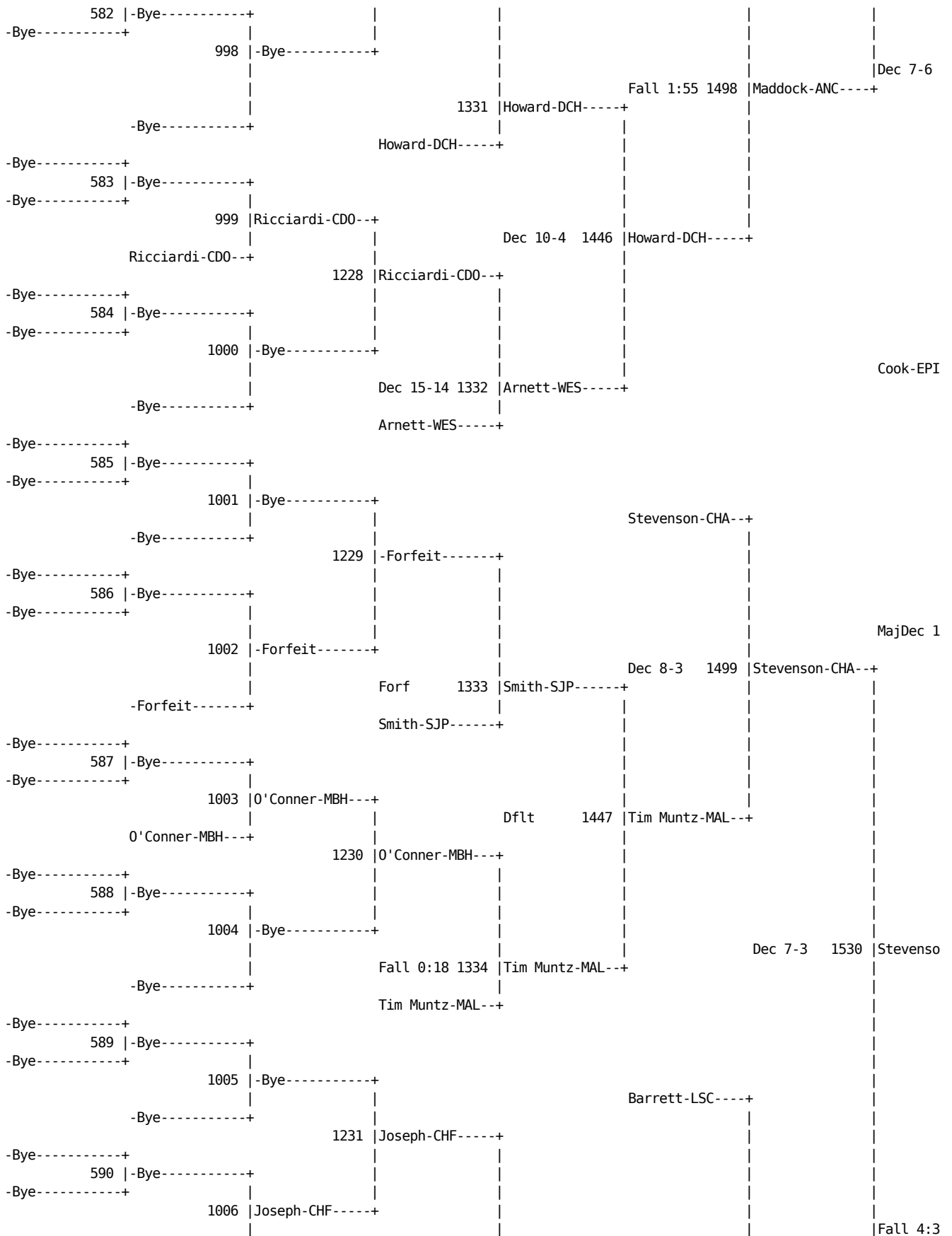

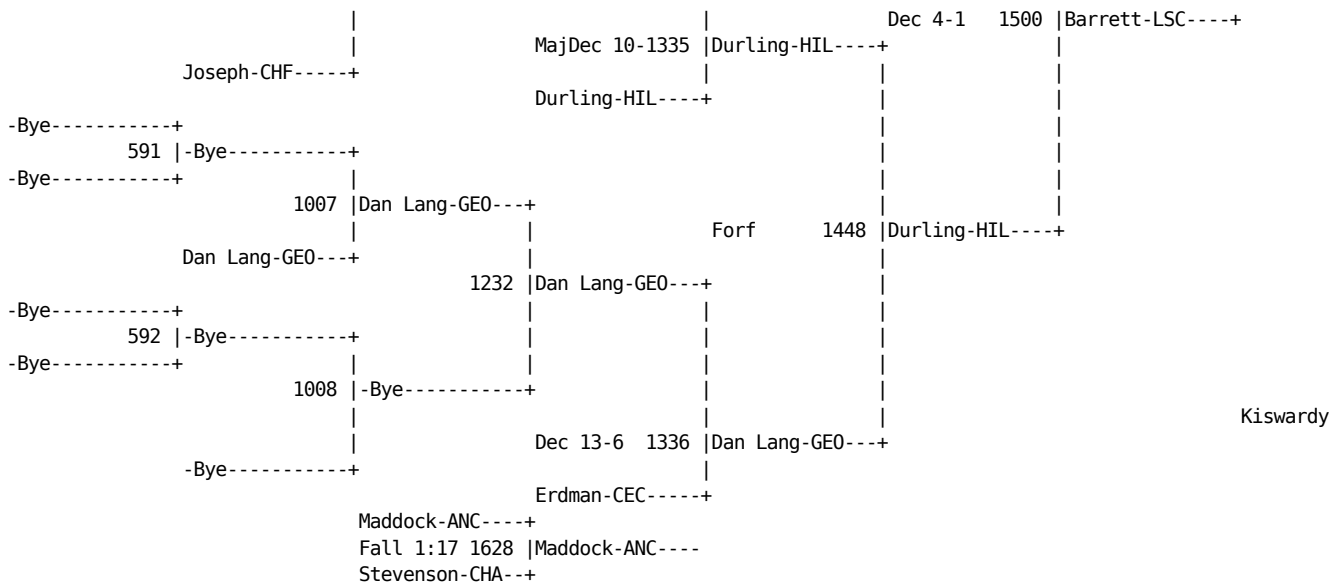

# PAISWT - 2001

16 - 17 February 2001

Wt: 189

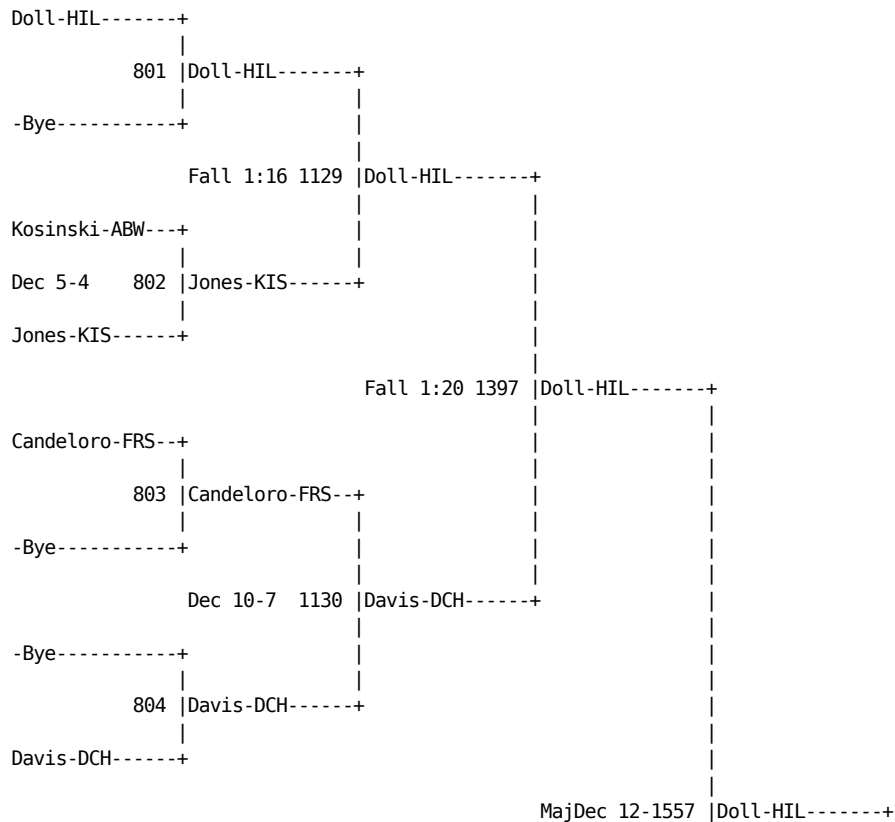

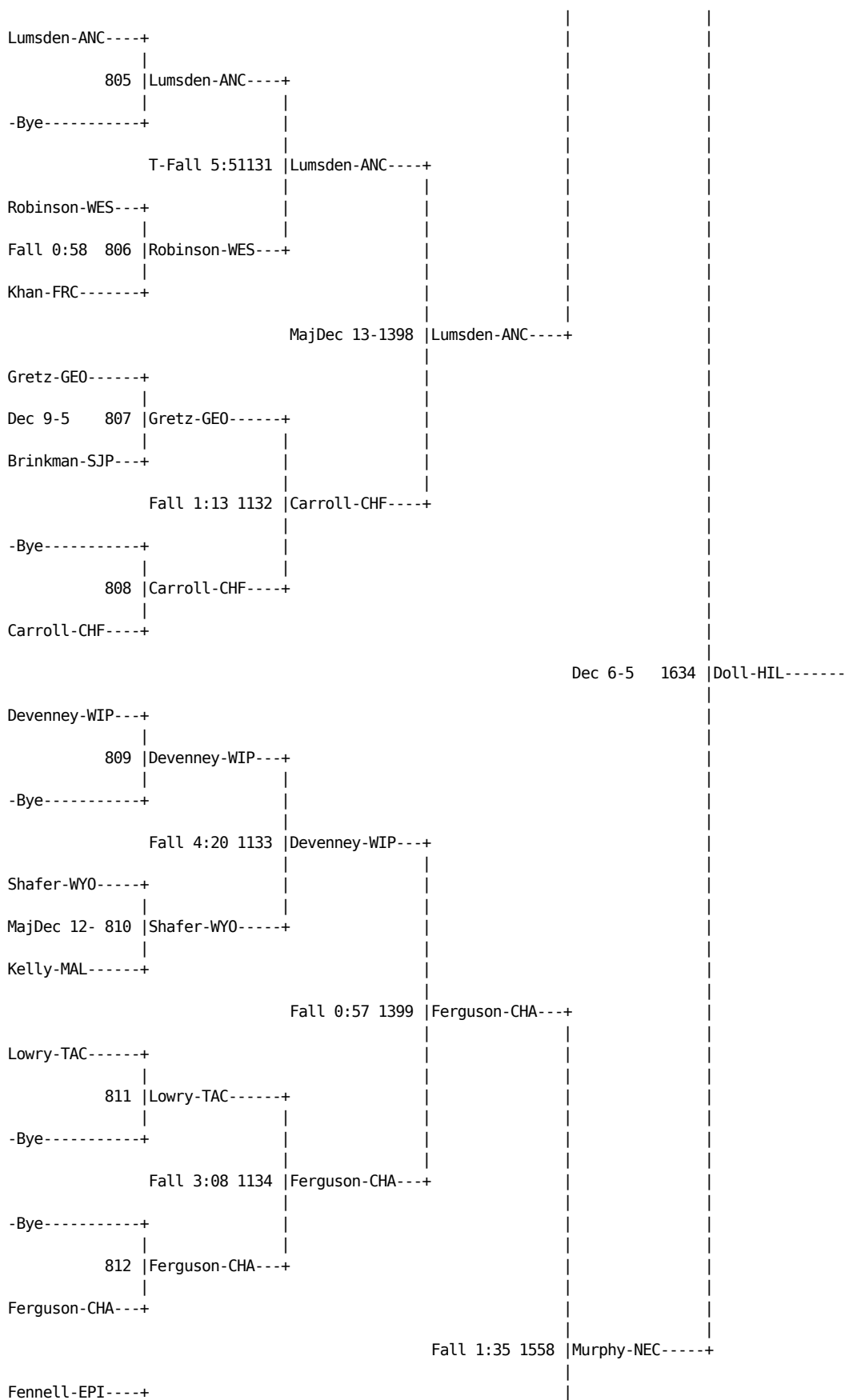

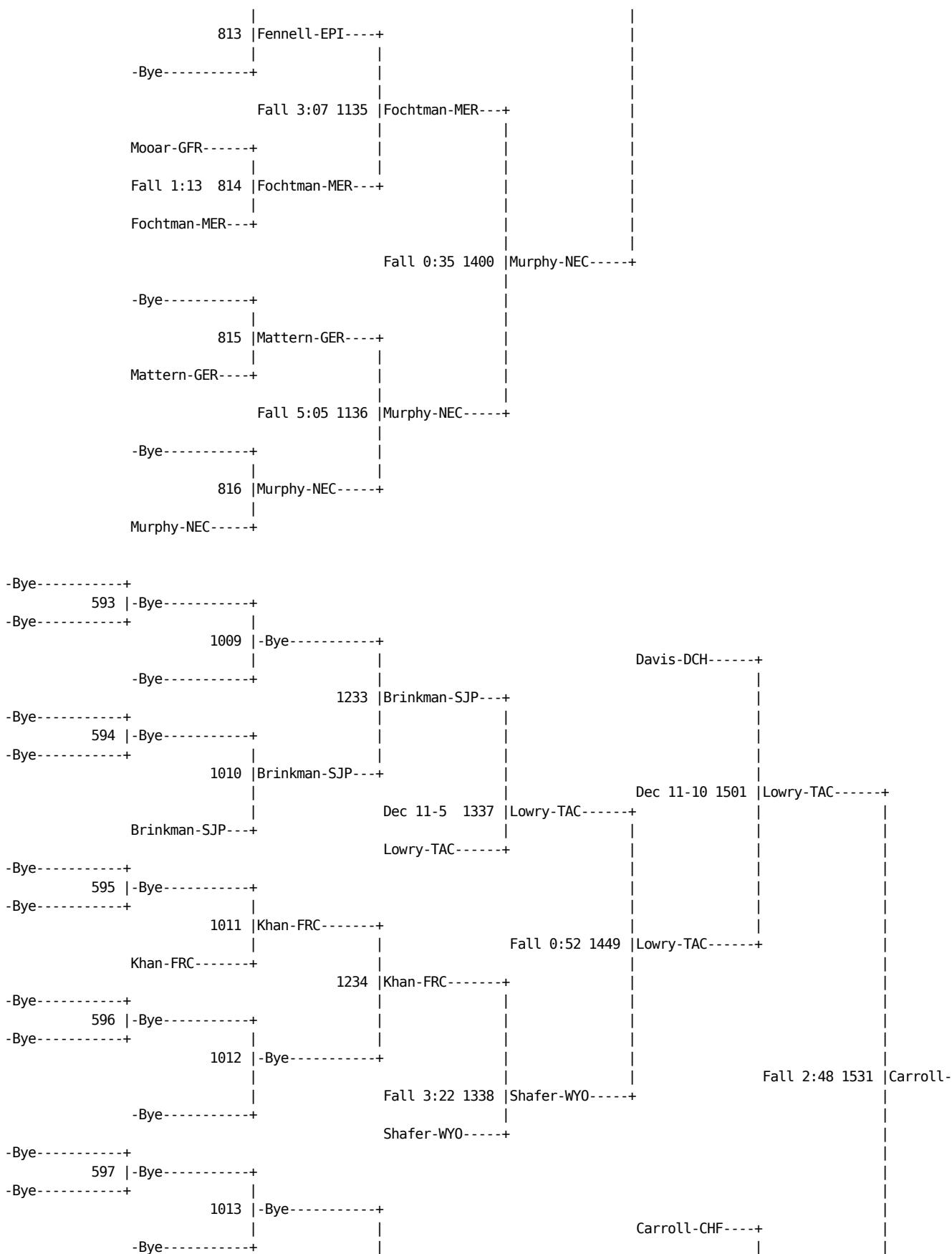

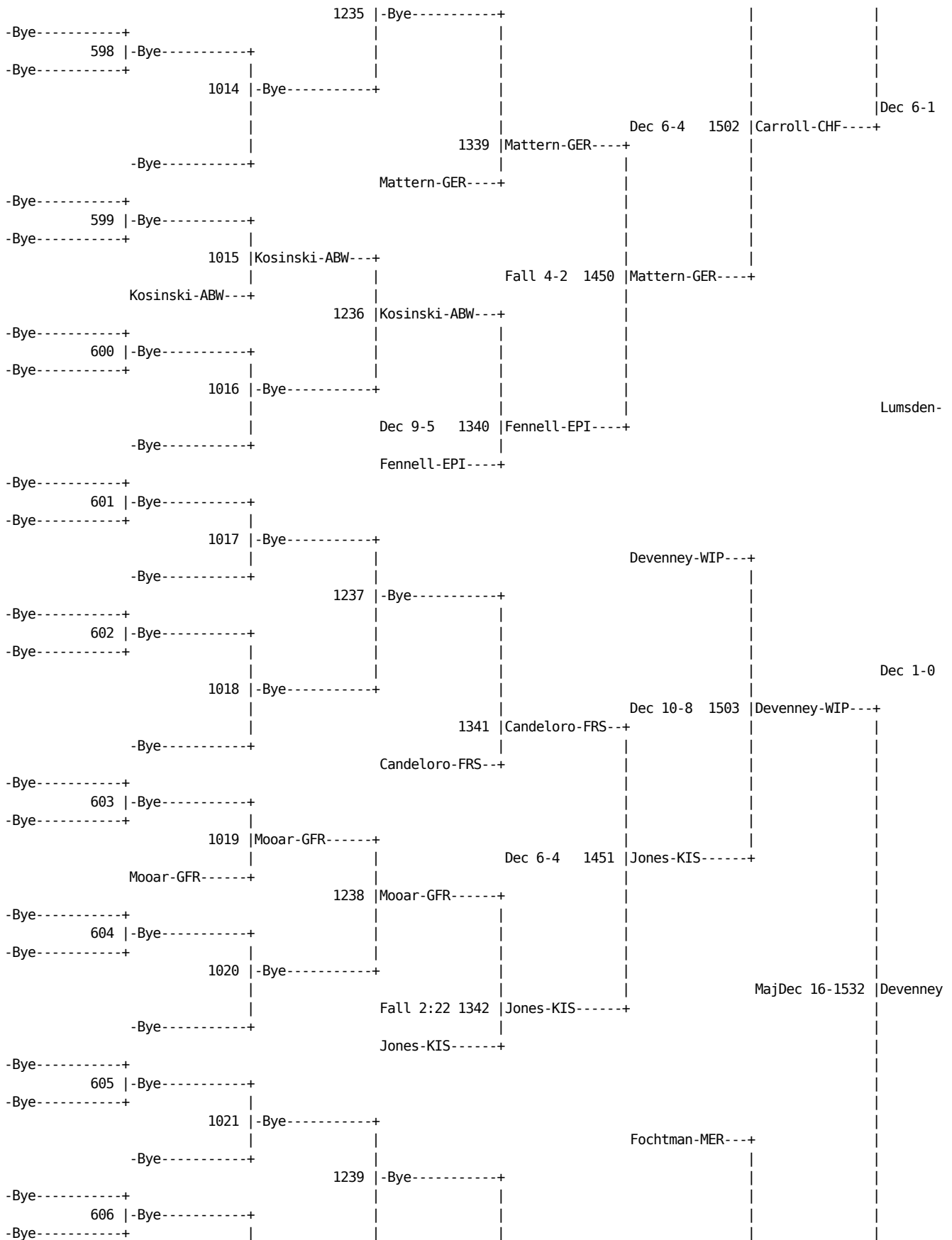



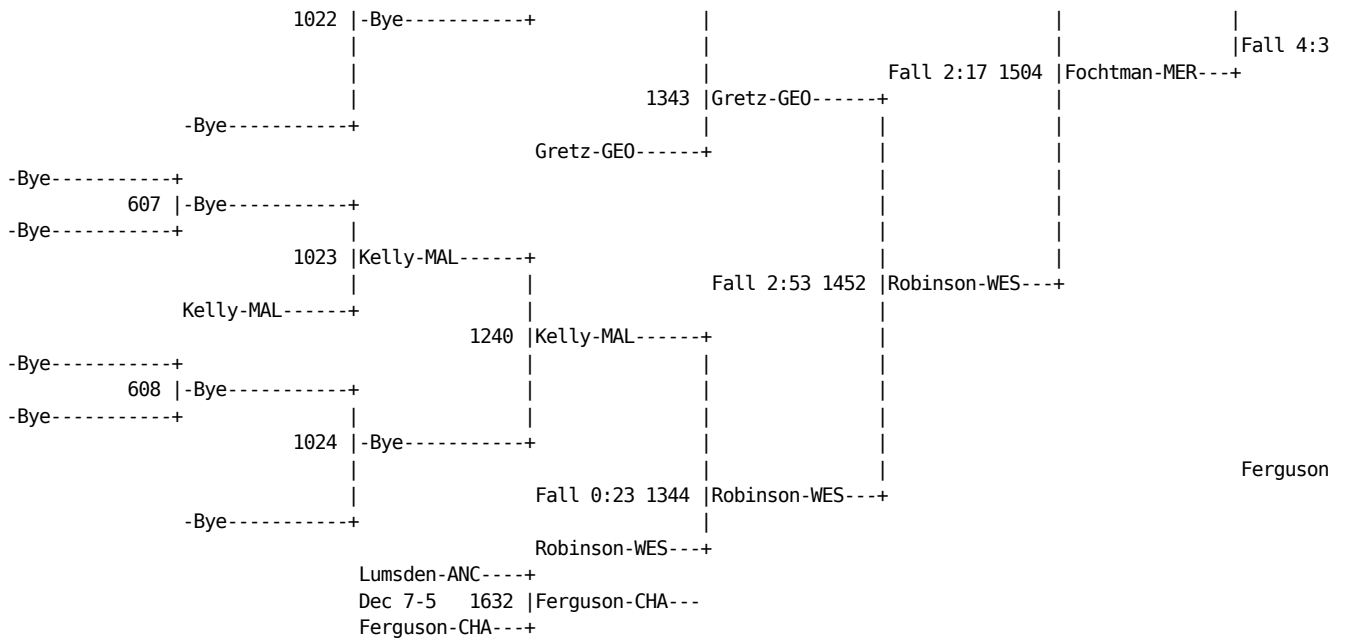

# PAISWT - 2001

## 16 - 17 February 2001

Wt: 275

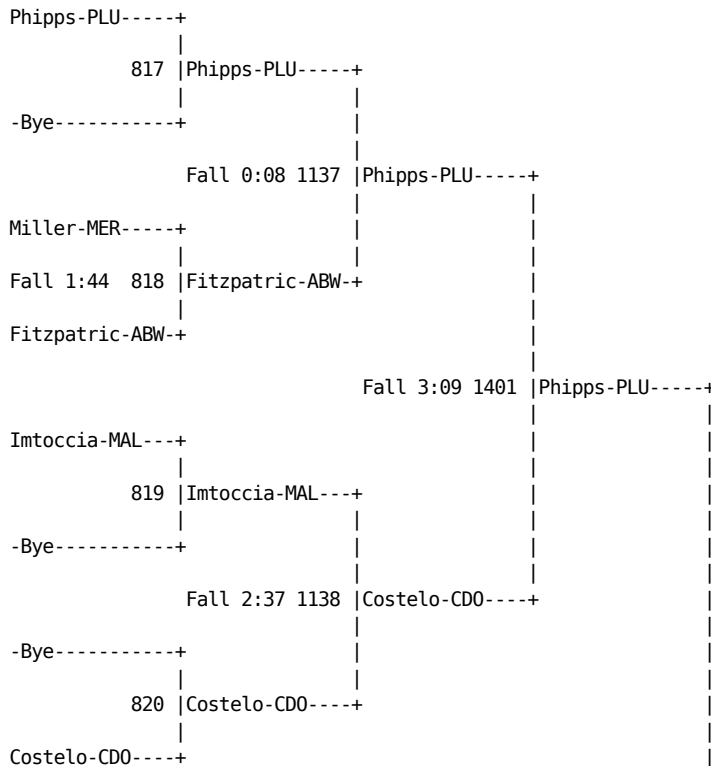

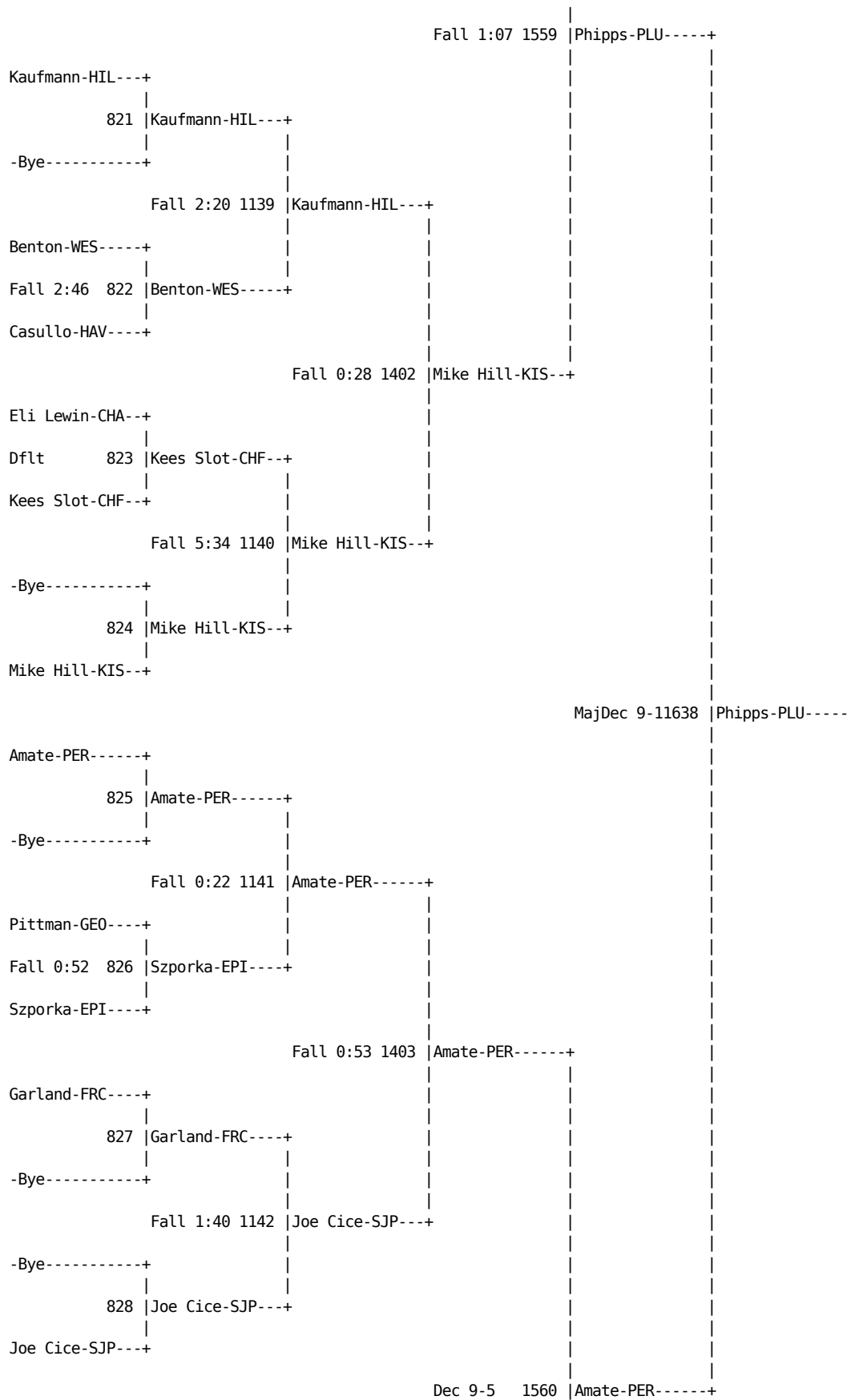

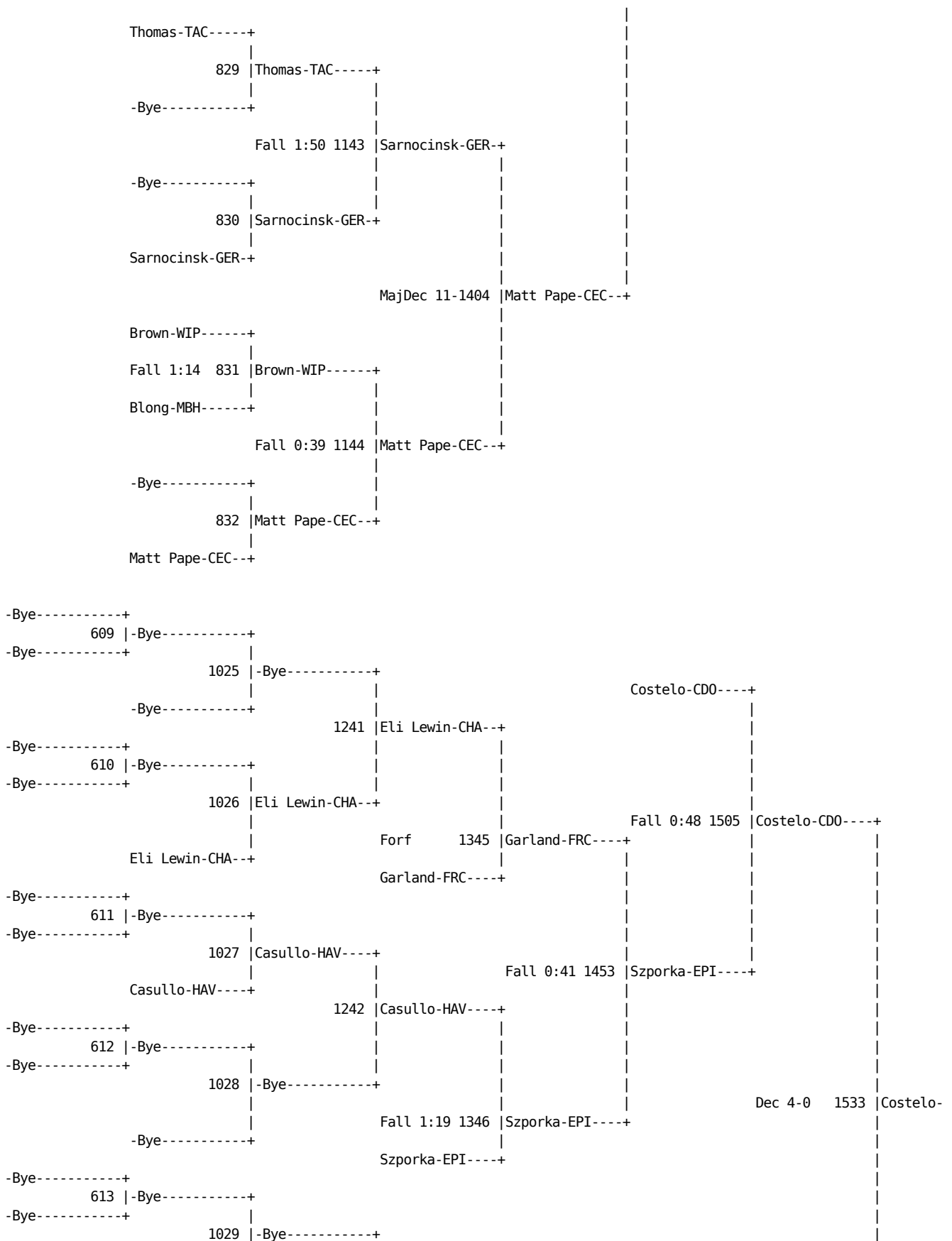



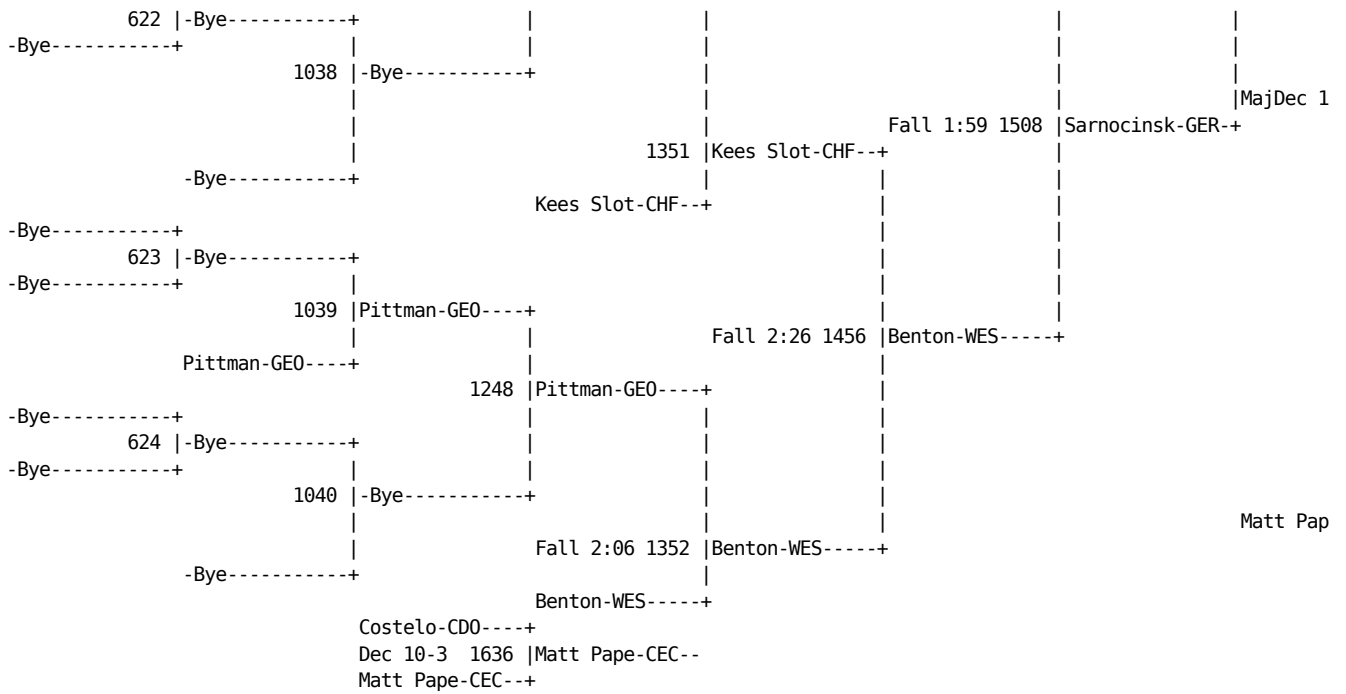

**Preferred Educational Software**

9585 Woodgate Lane

Byron IL 61010

Phone: (815) 234-5122

e-mail: [cotterk@pes-sports.com](mailto:cotterk@pes-sports.com)

(C) 1997 - All rights reserved